

Alcohol Detection with Automatic Engine Locking System

P.Sree Lekha, Dr.P.Venkata Prasad

Department of EEE, Chaitanya Bharathi Institute of Technology (Autonomous), Hyderabad

Submitted: 25-05-2021

Revised: 01-06-2021

Accepted: 05-06-2021

ABSTRACT:

This paper proposes an efficient technique for eradicating the upsurge in the number of cases of roads accidents caused by excessive intake of alcohol by drivers on the roads. A prototype alcohol detection and engine locking system is developed by using an Arduino Uno microcontroller interfaced with an alcohol sensor along with an LCD screen and a DC motor. The system uses MQ-3 alcohol sensor to continuously monitor the blood alcohol content (BAC) to detect the existence of liquor in the exhalation of a driver. By placing the sensor on the steering wheel, our system has the capacity to continuously check alcohol level from the driver's breath. The ignition will fail to start if the sensors detect content of alcohol in the driver's breath. In case the driver got drunk while driving, the sensor will still detect alcohol in his breath and stop the engine so that the car would not accelerate any further and the driver can park by the roadside.

In 2016, 10,497 people died in alcohol-impaired driving crashes, accounting for 28% of all traffic-related deaths in the United States. Of the 1,233 traffic deaths among children ages 0 to 14 years in 2016, 214 (17%) involved an alcohol-impaired driver. In 2016, more than 1 million drivers were arrested for driving under the influence of alcohol or narcotics. That's one percent of the 111 million self-reported episodes of alcohol-impaired driving among U.S. adults each year is shown in figure.

Drugs other than alcohol (legal and illegal) are involved in about 16% of motor vehicle crashes. Marijuana use is increasing and 13% of nighttime, weekend drivers have marijuana in their system.

Marijuana users were about 25% more likely to be involved in a crash than drivers with no evidence of marijuana use, however other factors—such as age and gender—may account for the increased crash risk among marijuana users.

Annual Self-reported Alcohol-impaired Driving Episodes among U.S. Adults, 1993–2014

I. INTRODUCTION:

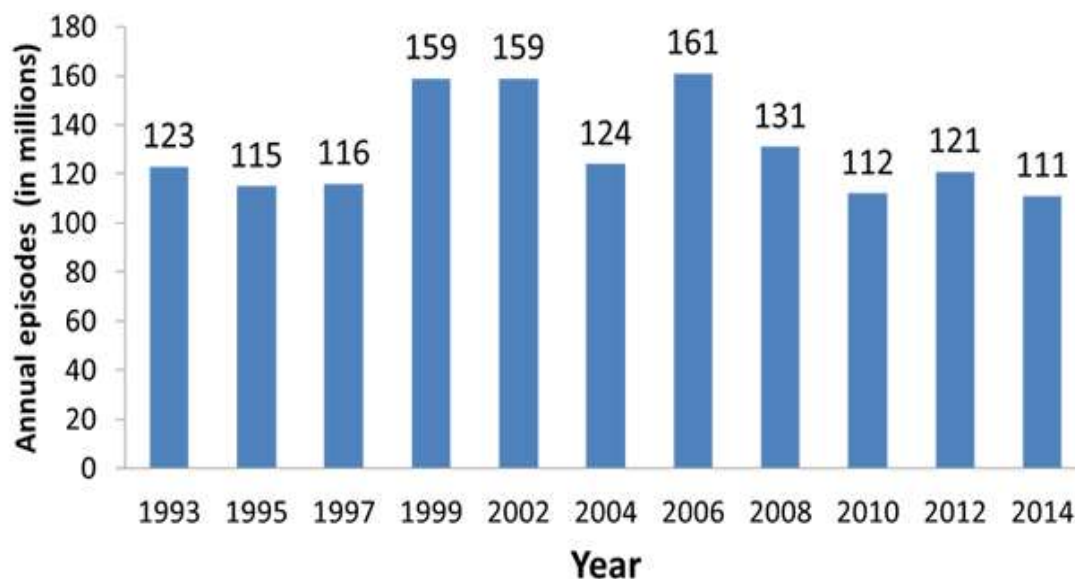

1.1 Who is most at risk?

Young people:

At all levels of blood alcohol concentration (BAC), the risk of being involved in a crash is greater for young people than for older people.

Among drivers with BAC levels of 0.08% or higher involved in fatal crashes in 2016, nearly three in 10 were between 25 and 34 years of age (27%). The next two largest groups were ages 21 to 24 (26%) and 35 to 44 (22%).

Motorcyclists:

Among motorcyclists killed in fatal crashes in 2016, 25% had BACs of 0.08% or greater.

Motorcyclists ages 35-39 have the highest percentage of deaths with BACs of 0.08% or greater (38% in 2016).

Drivers with prior driving while impaired (DWI) convictions:

Drivers with a BAC of 0.08% or higher involved in fatal crashes were 4.5 times more likely to have a prior conviction for DWI than were drivers with no alcohol in their system. (9% and 2%, respectively).

Drivers are considered to be alcohol-impaired when their blood alcohol concentrations (BACs) are .08 grams per deciliter (g/dL) or higher. Thus, any fatal crash involving a driver with a BAC of .08 g/dL or higher is considered to be an alcohol-impaired-driving crash, and fatalities occurring in those crashes are considered to be alcohol-impaired-driving fatalities. The term "drunk driving" is used instead of alcohol-impaired driving in some other NHTSA communication and material. The term "driver" refers to the operator of any motor vehicle, including a motorcycle. Estimates of alcohol-impaired driving are generated using BAC values reported to the Fatality Analysis Reporting System (FARS) and BAC values imputed when they are not reported. In this fact sheet, NHTSA uses the term "alcohol-impaired" in evaluating the FARS statistics. In all cases throughout this fact sheet, use of the term does not indicate that a crash or a fatality was caused by alcohol impairment, only that an alcohol-impaired driver was involved in the crash.

New Delhi: The per capita alcohol consumption in India increased two folds between 2005 and 2016, according to the Global status report on alcohol and health 2018 released by the World Health Organization (WHO) on

Saturday. Indians consumed 2.4 liters of alcohol in 2005, which increased to 4.3 litres in 2010 and scaled up to 5.7 liters in 2016, the report said. According to the report, the highest increase in alcohol consumption is expected in South-East Asia, with an increase of 2.2 liters in India alone, from 2005 to 2016.

More than 3 million people died as a result of harmful use of alcohol in 2016, the report said. More than three quarters of those reported dead were men. Overall, the harmful use of alcohol causes more than 5% of the global disease burden. The report highlighted that 51.1 men per 100,000 population and 27.1 women per 100,000 population suffered from liver cirrhosis. Cancers associated with alcohol abuse resulted in 181 men per 100,000 population and 126.4 women per 100,000 population. Of all deaths due to alcohol, 28% were from injuries, such as those from traffic crashes, self-harm and interpersonal violence; 21% due to digestive disorders; 19% due to cardiovascular diseases, and the remaining due to infectious diseases, cancers, mental disorders and other health conditions. "Far too many people, their families and communities suffer the consequences of the harmful use of alcohol through violence, injuries, mental health problems and diseases such as cancer and stroke," according to Tedros Adhanom Ghebreyesus, director-general, WHO. "It's time to step up action to prevent this serious threat to the development of healthy societies."

According to the report, almost all (95%) of countries globally have alcohol excise taxes, but fewer than half of them use other price strategies such as ban on volume discounts. The majority of these countries have some type of restrictions on beer advertising, with bans most common for television and radio, but less common for the Internet and social media.

II. PROPOSED METHODOLOGY:

Using Arduino Uno microcontroller, we propose to design a system consisting of an alcohol sensor, MQ3, to detect the presence of alcohol by analyzing a person's breath and shutting down the vehicle's engine when a specific amount of alcohol is detected to prevent any kind of mishap or accident that may occur due to the driver taking control over the vehicle. Hence, drunken driving is controlled, thereby minimizing the loss of life and property.

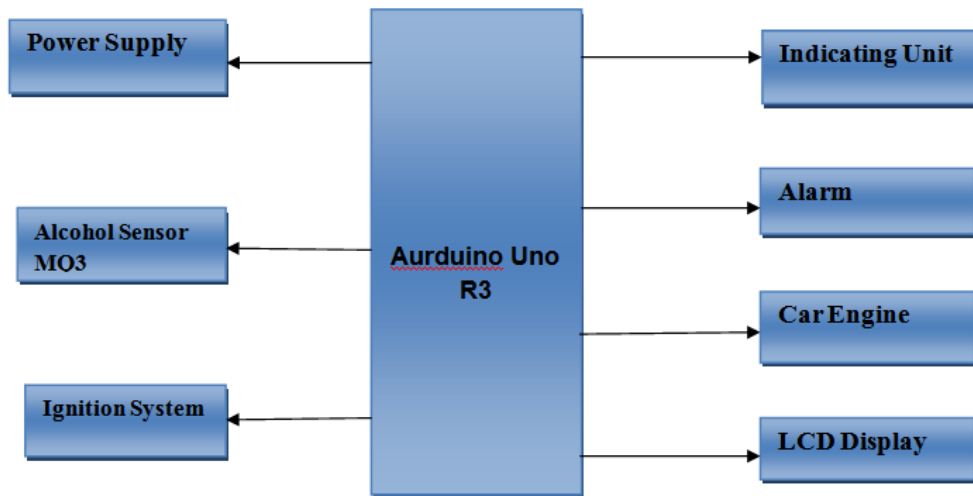

Fig. 1: Block diagram of Alcohol detection of drunk drivers with automatic car engine locking system.

2.1 Power Supply Unit :

Our system is powered with a 9V battery. A 5V DC supply as required by the microcontroller, sensor and display unit. While other components like DC motor require 1.5V and the LEDs need 2V. The Arduino Uno board has already been designed to operate without the use of transformer, the system can be powered via the USB connection from computer or with an external power supply of 7 to 12V. The External (non-USB) power can come either from an AC-to-DC adapter (wall-wart) or battery. Any voltage that is above 12V will make the control device to burn thereby destroying the board. It is advisable to use voltage between 7 - 12V.

2.2 ATmega328 Microcontroller Unit :

The proposed system is built around ATmega328 Arduino Uno microcontroller board. The unit consists of 14 pins which allows inflow and outflow of feeding (it is possible to use 6 of those pins as Pulse Width Modulation signal outputs), 6 continuous signal with time changing quantity, 16 megahertz electronic oscillator, a Universal Serial Bus port, a power connector, an on-board voltage regulator, ICSP header, and a reset button. The ATmega328 has 32 KB flash memory, 2 KB SRAM and 1 KB EEPROM.

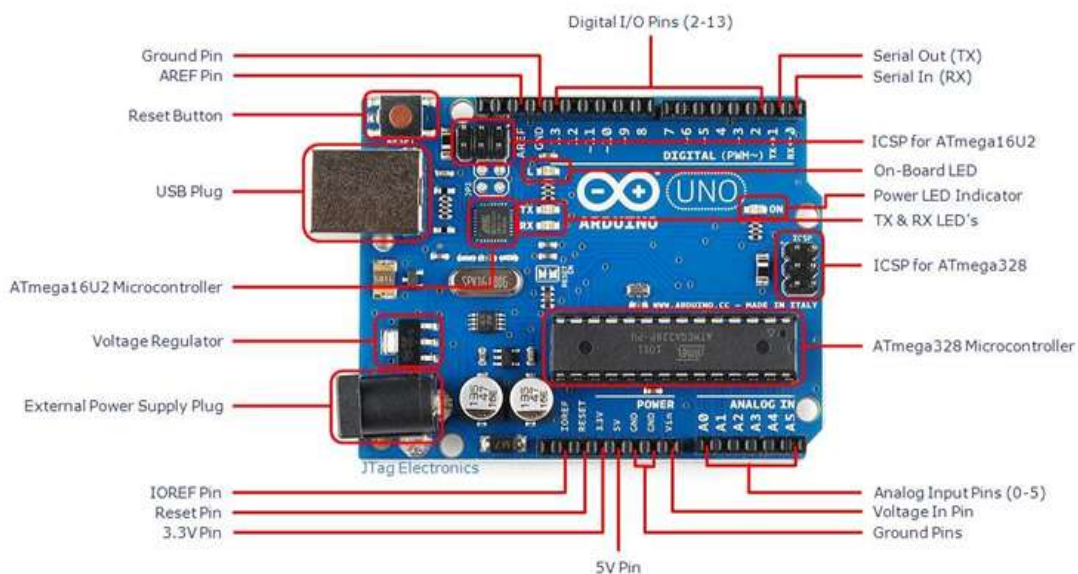

Fig. 2: Arduino Uno ATmega328 microcontroller unit

2.3 MQ-3 Alcohol Sensor Unit

The sensor is made of Tin Dioxide (SnO_2) sensitive layer. The sensor is configured with a high sensitivity to alcohol and small sensitivity to Benzene. It has a simple drive circuit with fast

response, stability, and long life. It has an analog interface type. On the sensor, port pins 1, 2 and 3 represents the output, GND and V_{CC} respectively. The technical specification of the sensor is portrayed in table .

A. Standard work condition

Symbol	Parameter name	Technical condition	Remark
Vc	Circuit voltage	5V±0.1	AC OR DC
VH	Heating voltage	5V±0.1	AC OR DC
RL	Load resistance	200KΩ	
RH	Heater resistance	33Ω±5%	Room Tem
PH	Heating consumption	less than 750mw	

B. Environment condition

Symbol	Parameter name	Technical condition	Remarks
Tao	Using Tem	10°C-50°C	
Tas	Storage Tem	20°C-70°C	
RH	Related humidity	less than 95%Rh	
O ₂	Oxygen concentration	21%(standard condition)Oxygen concentration can affect sensitivity	minimum value is over 2%

C. Sensitivity characteristic

Symbol	Parameter name	Technical parameter	Remarks
Rs	Sensing Resistance	1MΩ- 8 MΩ (0.4mg/L alcohol)	Detecting Concentrations scope : 0.05mg/L—10mg/L Alcohol
α (0.4/1 mg/L)	Concentration slope rate	0.6	
Standard detecting condition	Temp: 20°C±2°C Vc:5V±0.1 Humidity: 65%±5% Vh: 5V±0.		
Preheat time	Over 24 hour		

The circuit diagram of the MQ-3 sensor is shown in figure. In the datasheet, the recommended value to be used ranges from 100k ohm to 470k ohm. Here, 200k ohm was used.

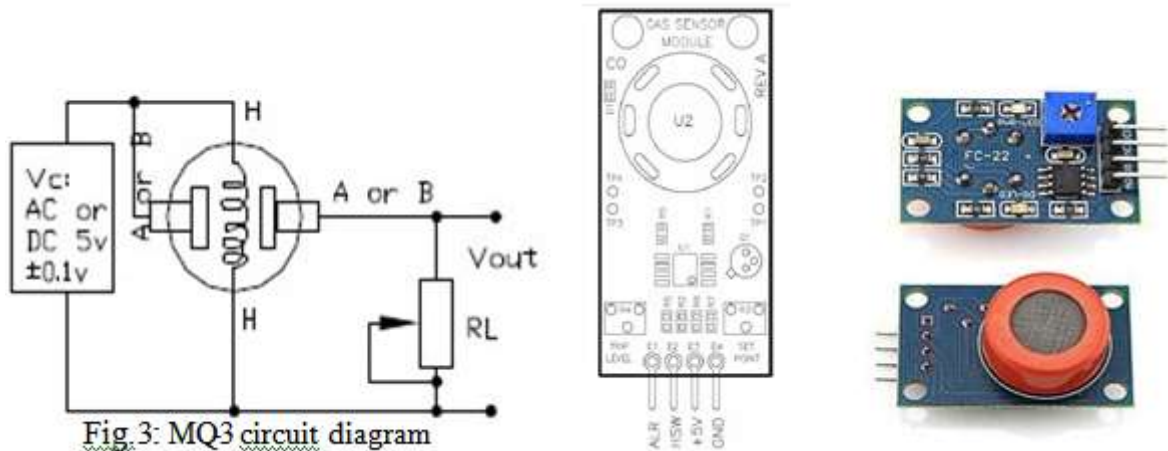

Fig.3:Circuit diagram of MQ3 alcohol sensor.

2.4 Alarm and Indicating Unit

The alarm unit used is a buzzer which indicates when alcohol is detected. The buzzer used belongs to the PS series. The PS series are high-performance buzzers that employ Uni-morph piezoelectric elements and are designed for easy incorporation into various circuits. They have very low power consumption in comparison to electromagnetic units. It has a voltage requirement of 2V and is connected to pin 10 of the microcontroller. The standard resistor value of 220 Ω commercially available is closest to the computed value of 250 Ω, so a 220 Ω resistor was used to limit the current going through the LEDs.

2.5 DC Motor

The DC motor is an electric DC motor used to demonstrate the concept of engine locking. Here in this work, the DC motor will be connected to pin 9 on the microcontroller, when alcohol is detected the DC motor stops in order to indicate

that alcohol is detected and continue running when there is no alcohol detected.

2.6 System Flow chart

The flow chart of the system is shown in figure 6. The system algorithm comprises of three main steps. First is to boot up the system, next is the measuring state, this stage measure the amount of alcohol level from the drivers. A prescribed set limit will be given as input to the microcontroller, once the alcohol level exceeds the limit the car will not start.

- STEP 1: Power on the system
- STEP 2: checks for alcohol concentration
- STEP 3: if alcohol is detected
- STEP 3.1: turn off car engine
- STEP 4: Else
- STEP 5: Car engine running
- STEP 6: Go to step 1

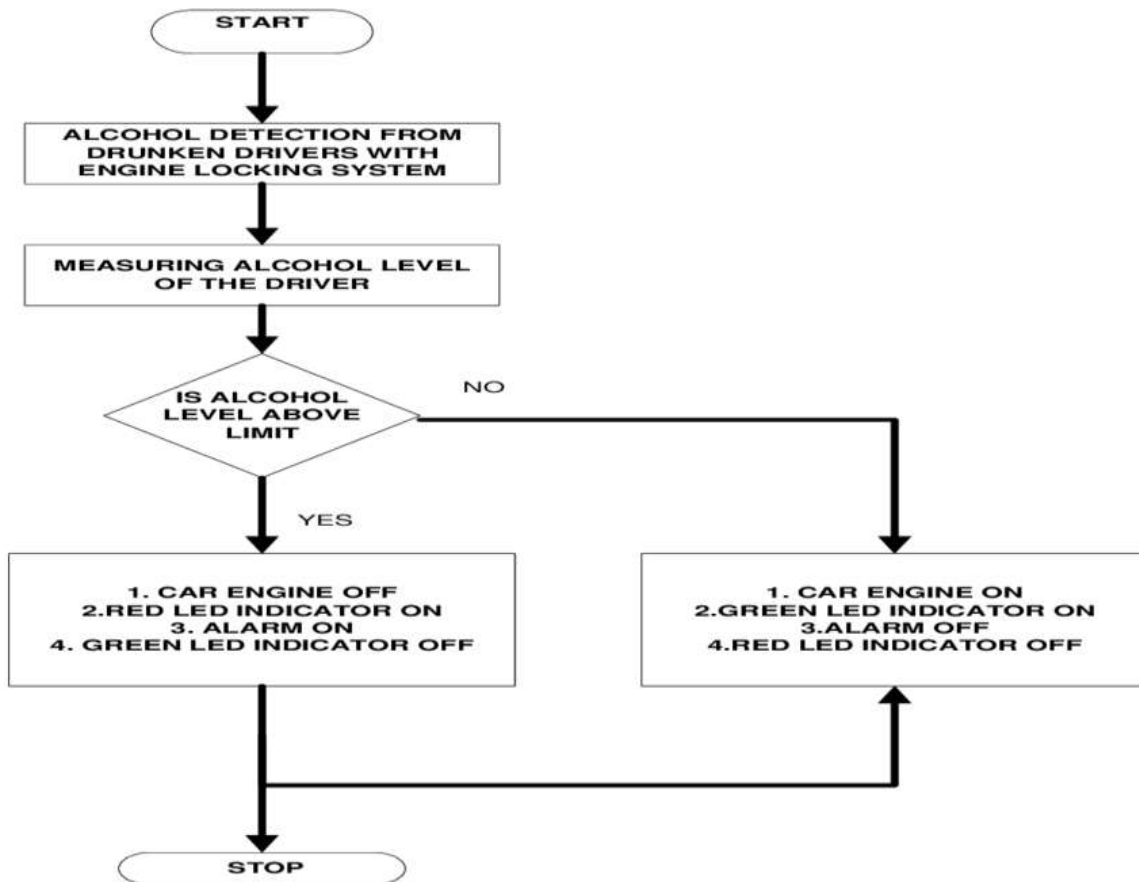

Fig. 4. Flow chart of alcohol detection system.

2.7 System Operation

The detected analog voltage values are read by the microcontroller; the Arduino Uno board contains 8 channels, 10-bit device that changes an analog voltage on a pin to a digital number. The system will link input voltages from 0-5V with values from 0-1023V to generate 5Vs for every 1024 units. The system will process the analog signal and convert it to digital value of 0 or 1. Also, the analog values from the alcohol sensor will be scaled to percentage, and this percentage is equivalent to the analog voltage values in ppm (part per million). The first condition is the intoxication stage; the second condition is the slightly drunk stage and the last stage is drunkenness stage. Each stage will be a condition to perform a task based on the level of alcohol. In the intoxication stage, the LED indicator will be activated only, the alarm will be OFF and the car engine will be ON. In stage two, the alarm and the

green LED indicator will be ON, as well as the car engine. Finally, the driver is mentally and physically inactive in stage three, so the engine will be OFF while the alarm and red LED will be ON. Therefore, once the system detect alcohol in stage three the car will be stopped and the driver can park by the roadside.

Software Implementation :-

The software design consists of a free running program which manipulates input from the Alcohol sensor and programming of the indicating unit, LCD display, DC motor, alarm unit. The program code is written on Arduino sketch and uploaded to ATMEGA328 microcontroller program memory using Arduino Uno development board. The hex file is generated using the Arduino sketch IDE environment. Figure shows the device programming used for this research.

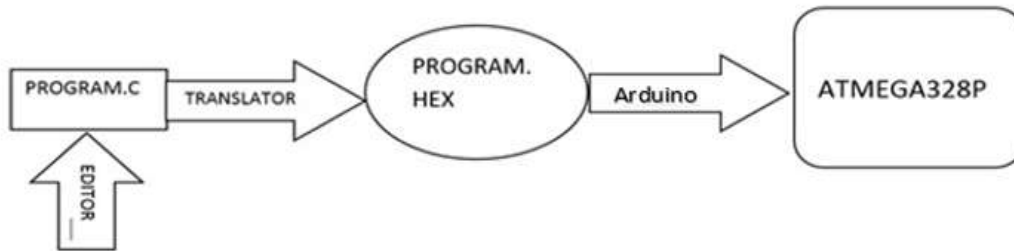

Fig.5:Device Programming

After generating the hex file from the Arduino sketch environment, the hex file was copied from the Arduino file directory and linked to the Proteus for simulation. Each unit was also tested to ensure continuity and efficiency in the components before soldering. Figure shows the full simulation design of our proposed system. Also, the location of hex file is depicted in figure .

In this stage, when the car is switched on the system measures the level of alcohol from the driver breath to check whether the driver is intoxicated, slightly drunk and whether if he is extremely drunk. Based on this, the microcontroller only locks the engine when the level exceeds 40% in which case car engine stops so that the driver can manage to stare the car to the road side. The unit for measuring alcohol level is depicted in figure.

III. ALCOHOL CHECKING STAGE

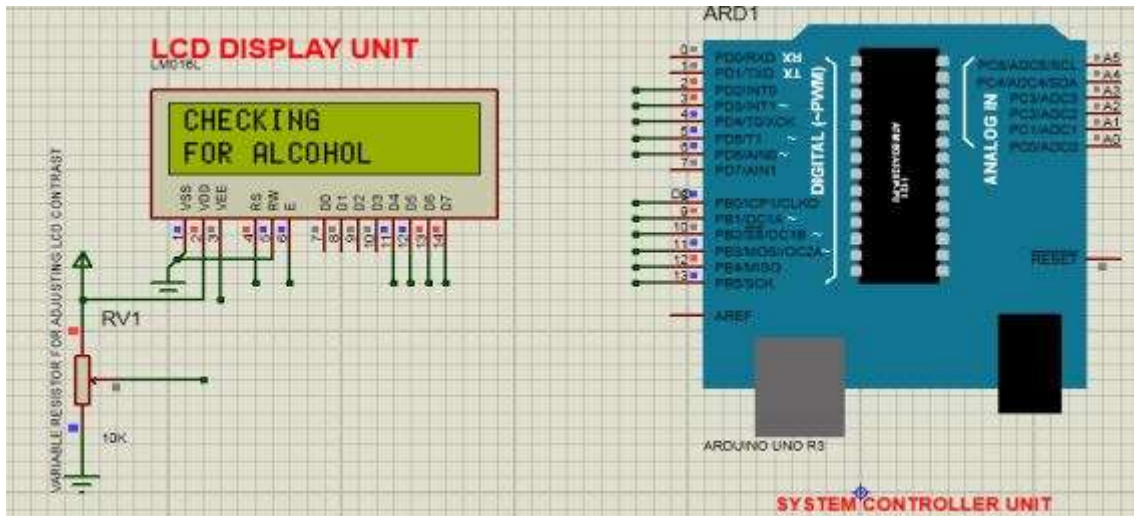

Fig.6:Measuring

1.1 Alcohol detection unit

The alcohol sensor unit has four pins; test pin, V_{cc} , D_{out} and ground. The test pin is used to accept logic signals of 0 or 1 by using logic state pin as shown in figure .The LED is used to show

when the sensor detect alcohol. in the simulation, when the logic state is 1 the led goes on to indicate that alcohol is present and off to show the absence of alcohol.

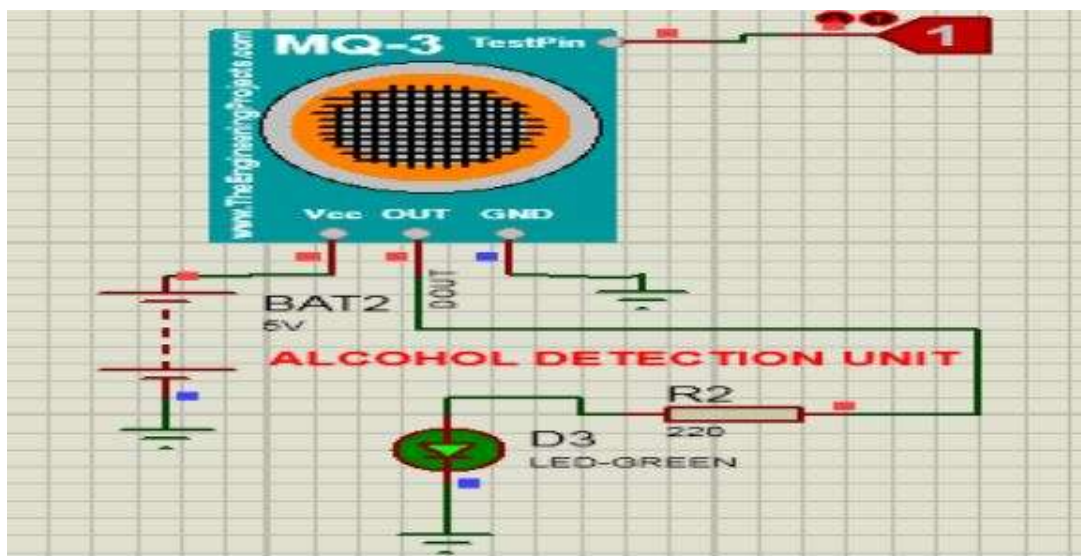

Fig.7:Detection Stage

Table 1 :Sensitivity Level Characteristics

Voltage (v)	PPM(Part Per Million)	PERCENTAGE(%)
0.5	0	0
1	100	10
1.5	200	20
2	300	30
2.5	400	40
3	500	50
3.5	600	60
4	700	70
4.5	800	80
5	900	90
5.5	1000	100

Table 2 : level of drunkenness

Voltage output	200-300ppm 0-1.5v 20-30%	300-400ppm 1.5-2v 30-40%	400-500ppm 2-2.5v 40-50%
LCD display	intoxicated	Slightly Drunk	Drunkenness
Alarm	Off	Off	on
Ignition system	On	On	Off
Indicator	Led Green On Led Red Off	Led Green On Led Red Off	Led Red On Led Green Off

The graph in figure shows the output voltages for alcohol detection in ppm obtained with the help of the above readings for different alcohol content samples. The response of the different samples is in parts per million (PPM) vs Alcohol Sensor Operating voltages in Volt.

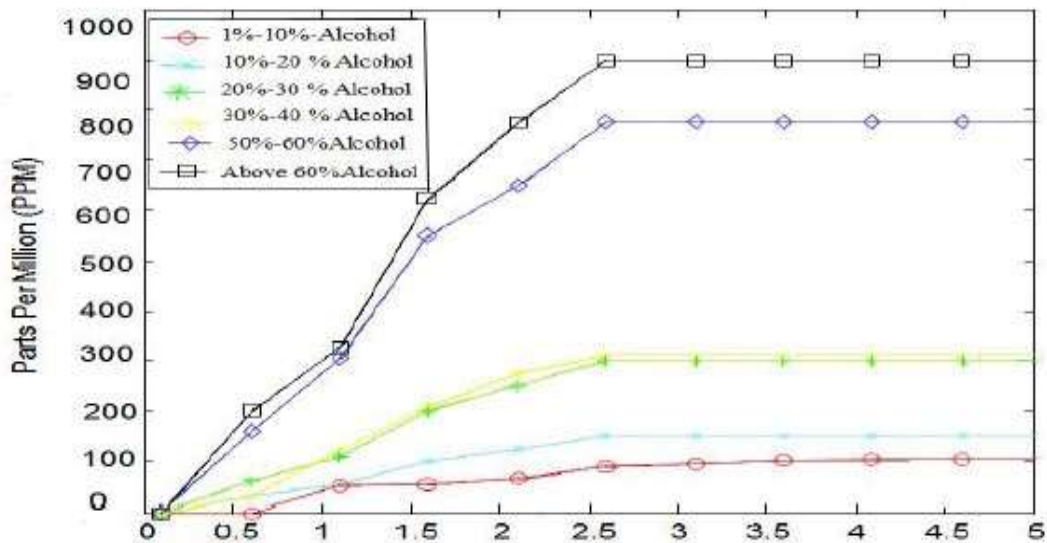

Fig.8: Response of ppm (In Percentage) via alcohol sensor output voltages value(4)

Figure below shows the graph of the voltage level at which the detection point takes effect. At 2V the car engine stops running and continues running once the alcohol level falls <2V.

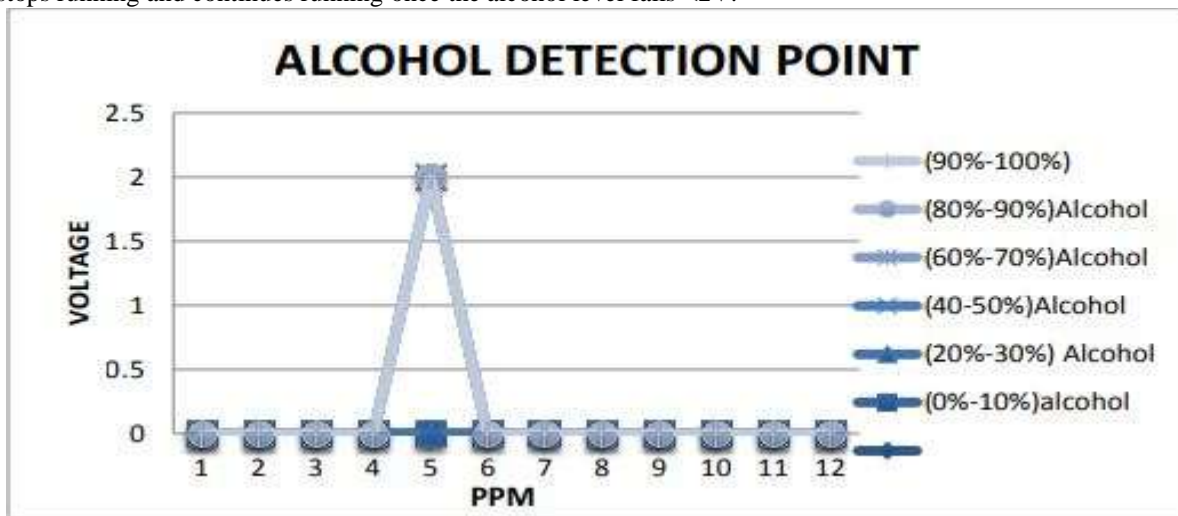

Fig .9:Alcohol Detection Point

IV. RESULTS AND DISCUSSION :

We tested the sensor’s accuracy using a deodorant perfume to simulate its response to alcohol concentration level. To verify the functionality of our system, we employed breadboard, digital multimeter, LEDs, Arduino sketch IDE, and Proteus VSM software. The final bread boarding of the entire system is shown in figure .

Alcohol Sensor Accuracy

Accuracy is the measurement of an instrument to give equivalent value to the true value or the quantity being measured. The accuracy can be related to the percentage error as

$$\text{Error} = \text{Actual reading} - \text{Experimental reading}$$

$$\text{Percentage error} = \frac{\text{Error}}{\text{Actual reading}} \times 100\%$$

From the experimental results obtained as shown in table, Total percentage error for the whole table = 45%. Therefore, Overall percentage error = Total percentage /total sample reading = 45/20 = 2.25%. The average accuracy of the alcohol sensor used is obtained as Ave % accuracy = 100 – 2.25% = 97.75 %. Thus, our calculation above shows that the alcohol sensor is 97.75% accurate.

Sensitivity Level Characteristics

Table shows the alcohol levels in ppm, voltage and percentage. The values in ppm correspond to the voltage and percentage. Our

system displays the percentage alcohol level to the driver. The ppm values are the concentration level, that is, BAC level. The voltage values increase or decrease based on the resistance of the alcohol sensor. Using this table, the locking concept was achieved by programming instruction to the microcontroller to lock the car engine when the alcohol sensor reading is above 40%. The microcontroller uses the analog voltage values coming from the sensor to determine whether the sensor reading is above the set limit. In essence, once the microcontroller receives analog value above 2V, it automatically compares it with the preset limit, if it is not the same the engine will stop.

Level of Drunkenness

Experimental results were obtained based on the three pre-designated conditions for drunk driving. In intoxication stage, the car engine will be running as the driver can still control himself. Also in the slightly drunk state, the system will still allow the engine to run. Finally, in the drunken state, the driver will lose stability and cannot make decisions. In that case, the engine automatically locks off. Table shows the level of drunkenness.

V. CONCLUSIONS

In this paper, we proposed a method to sense the presence of alcohol from the breath of drivers and curtail the catastrophic effects it can have on peoples' lives. The system was designed and implemented successfully via the use of Arduino Uno ATMEGA328 microcontroller and MQ-3 sensor. Experimental evaluation of the system showed that the alcohol sensor was able to deliver fast response when alcohol is detected. Also, the ability of the alcohol sensor to operate over a long time is a feature of the proposed system.

REFERENCES:

- [1]. Altaf SV, Abhinay S, Ansari E, Kaunain Md, Anwer R. Alcohol Detection and Motor Locking System. International Journal of Advanced Research in Electrical, Electronics and Instrumentation Engineering. 2017; 6(2): 989-993.
- [2]. Mandalkar RB, Pandore RN, Shinde MB, Godse VD. Alcohol Detection and Accident Avoidance using Locking with Tracking. International Journal of Advanced Research in Computer Science and Management Studies. 2015; 3(9): 142-147.
- [3]. Lee, Assessing the Feasibility of Vehicle-Based Sensors To Detect Alcohol Impairment. 2010, National Highway Traffic Safety Administration: Washington, DC.
- [4]. Dr. Pavan Shukla , Utkarsh Srivastava , Sridhar Singh , Rishabh Tripathi, Rakesh Raushan Sharma
- [5]. Cahalan,D., I. Cisin, and Crossley, American Drinking Practices: A National Study of Driving Behaviour and Attitudes. 1969, Rutgers University Press: New Brunswick, NJ.
- [6]. Babor , AUDIT: The alcohol use disorders identification Test: Guidelines for use in primary health care. 1992, Geneva, Switzerland: World Health Organization.
- [7]. Paul Baskett , Yi Shang , Michael V. Patterson , Timothy Trull , Towards A System for Body-Area Sensing and Detection of Alcohol Craving and Mood Dvsregulation , Â© 2013 IEEE.
- [8]. Prashanth KP, Padiyar K, Naveen KPH, Kumar KS. Road Accident Avoiding System using Drunken Sensing Technique. International Journal of Engineering Research and Technology. 2014; 3(10): 818-823.
- [9]. Marijuana - HealthyStartU
- [10]. Vijay J, Saritha B, Priyadharshini B, Deepeka S, Laxmi R. Drunken Driven Protection System. International Journal of Scientific and Engineering Research. 2011; 2(12):1-4.
- [11]. Dada Emmanuel Gbenga, Hamit Isseini Hamed, Adebimpe Adekunle Lateef, Ajibuwa Emmanuel, Opeyemi. Alcohol Detection of Drunk Drivers with Automatic Car Engine Locking System. Nova Journal of Engineering and Applied Sciences. 2017; vol 6, No 1