

Design and Monitoring of Soil Parameters and Controlling of Soil Moisture Using IoT based Smart Irrigation

Er. Shivali, Prof.(Dr.) Gurpreet Singh, Er. Ramandeep Kaur,

M.Tech CSE St. Soldier Institute of Engg. & Technology, Near NIT, Jalandhar

Professor, Department of CSE St. Soldier Institute of Engg. & Technology, Near NIT, Jalandhar

Assistant Professor Department of Computer Sc. & Engg.

St. Soldier Institute of Engg. & Technology, Near NIT, Jalandhar

Submitted: 15-05-2022

Revised: 20-05-2022

Accepted: 25-05-2022

ABSTRACT: Suitable soil water amount is an obligatory condition for ideal plant growth. Also, water being a crucial element for life nourishment, there is the prerequisite to circumvent its excessive use. Irrigation is a supreme consumer of water. This calls for the need to control water supply for irrigation purposes. Pasture should neither be over-irrigated nor under-irrigated. Soil Monitoring is one tool to provide soil information. Over time, systems have been applied so as to approach register this aim of which computerized procedure are the most accepted as they permit data to be gathered at high persistence with less work demand. Size of the current structure engage micro-processor based systems. These systems provide several technological supremacy but are high-priced, large, hard to sustain and less welcomed by the technologically untrained operators in the pastoral scheme. The objective of this research is to outline a manageable, facile to install technique to detect and specify the level of soil moisture that is endlessly managed with a view to attain pinnacle plant growth and concomitantly augment the obtainable irrigation resources.

Keywords: Soil Moisture Sensor, Arduino UNO, IOT, ESP8266

I. INTRODUCTION:

A soil moisture sensor is another type of water sensor. It works by measuring the electrical

conductivity of the ground in which it is buried. Wet earth transmits electric current better than dry earth and so the sensor can detect the presence of water in the soil by measuring its conductivity. When the amount of moisture brings the current capacity up to a preset level, the sensor sends a signal to the controller. The moisture level can be adjusted on the sensor. It should be placed a few inches in the ground at a well-drained spot in the yard (a location high enough that water from the surrounding area does not drain into it and produce false high-moisture readings for the yard). Since a moisture sensor senses water in only one tiny spot and is used to represent the entire yard in the controller program, its placement should be carefully selected so it is a fair example of the landscaped area.

II. CIRCUIT DIAGRAM

The design of the circuit is very simple. Connect the probe to the board and provide power supply to the board. Take the analog out pin from the board and connect it to Analog IN pin A0 of the Arduino.

To view the results, I have used a 16×2 LCD Display, where I have connected its data pins D4 – D7 to Arduino Pins 5 – 2. All the additional connections are mentioned in the circuit diagram.

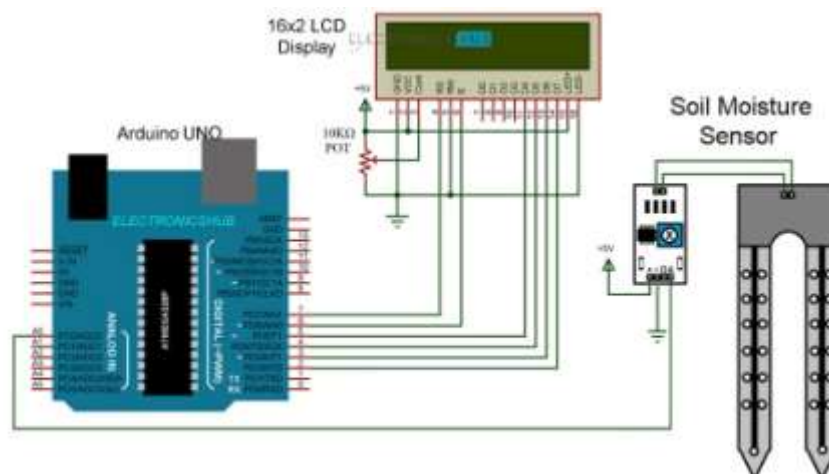

Fig. 1: Circuit diagram of Soil Moisture Sensor with Arduino UNO

III. OBJECTIVES OF THE STUDY

1. To implement IoT based environment friendly ecosystem with Sensor network for soil monitoring in agricultural areas using sensor like soil moisture
2. To communicate and store the data in the cloud for analytics.
3. To presents a system to predict the category of the analyzed soil datasets to indicate the yielding of the crop.

IV. HARDWARE OVERVIEW

A typical soil moisture sensor has two components.

V. THE PROBE

The sensor contains a fork-shaped probe with two exposed conductors that goes into the soil or anywhere else where the water content is to be measured.

Like said before, it acts as a variable resistor whose resistance varies according to the soil moisture.

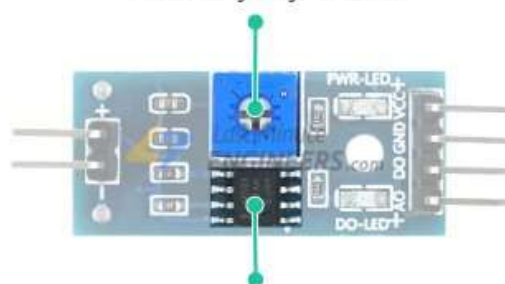

Fig. 2: Shows the first component of soil moisture

VI. THE MODULE

The sensor also contains an electronic module that connects the probe to the Arduino. The module produces an output voltage according to the resistance of the probe and is made available at an Analog Output (AO) pin.

Sensitivity Adjustment



LM393 Comparator

Fig. 3: Shows the electronic module of soil moisture

The module has a built-in potentiometer for sensitivity adjustment of the digital output (DO). You can set a threshold by using a potentiometer; So that when the moisture level exceeds the threshold value, the module will output LOW otherwise HIGH.

VII. SOIL MOISTURE SENSOR PINOUT

The soil moisture sensor is super easy to use and only has 4 pins to connect.

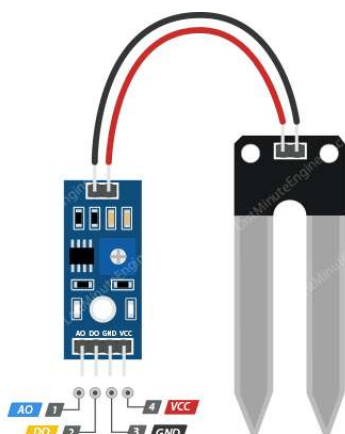

Fig. 4: Shows the connections between components

VIII. FLOW CHART OF THE STUDY

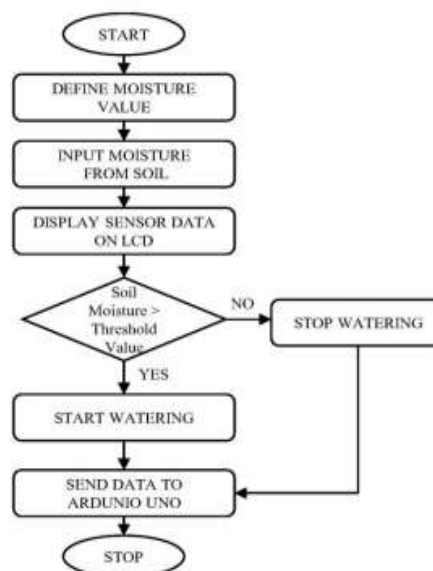

Fig. 5: Shows the flowchart of the study

APPROPRIATE SOIL MOISTURE LEVELS BY SOIL TYPE

Because this post can't cover every type of crop out there, here is a general reference table of broadly applicable "ideal moisture levels" for the three major types of soil (when tested using Delmhorst's KS-D1 soil moisture meter):

Table 1: Shows Appropriate Soil Moisture Levels by Soil Type

Soil Type	No Irrigation Needed	Irrigation to Be Applied	Dangerously Low Soil Moisture
Fine (Clay)	80-100	60-80	Below 60
Medium (Loamy)	88-100	70-88	Below 70
Coarse (Sandy)	90-100	80-90	Below 80

You might notice that the "fine" soil type has a wider moisture content zone where no irrigation is needed than the others. This is because fine, clay-like soil does a better job of retaining moisture than loamy or sandy soils.

It's important to note that this is a guideline, not a hard and fast rule. After all, most

farms will have soil that sits on a gradient somewhere between the three types specified in the table above. Additionally, the numbers above are not a quantitative percentage of moisture in the soil, but an estimate of how close the soil is to complete saturation.

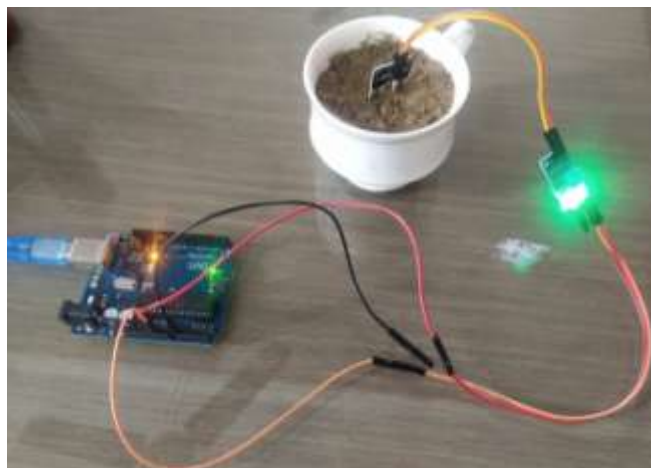

Fig. 6::Working Model of Soil Moisture Sensor

Table 2: Real Time values of soil moisture of Corn and Wheat corps based on irrigation factors

Irrigation Factors	Corn	Wheat
Irrigation to be applied	65.49	
No Irrigation Needed		80.55
Irrigation to be applied		62.42
Dangerously low soil moisture	40.58	
Dangerously low soil moisture		54.94
Dangerously low soil moisture	39.17	
Irrigation to be applied		78.52
Dangerously low soil moisture		59.87
No Irrigation Needed	85.62	

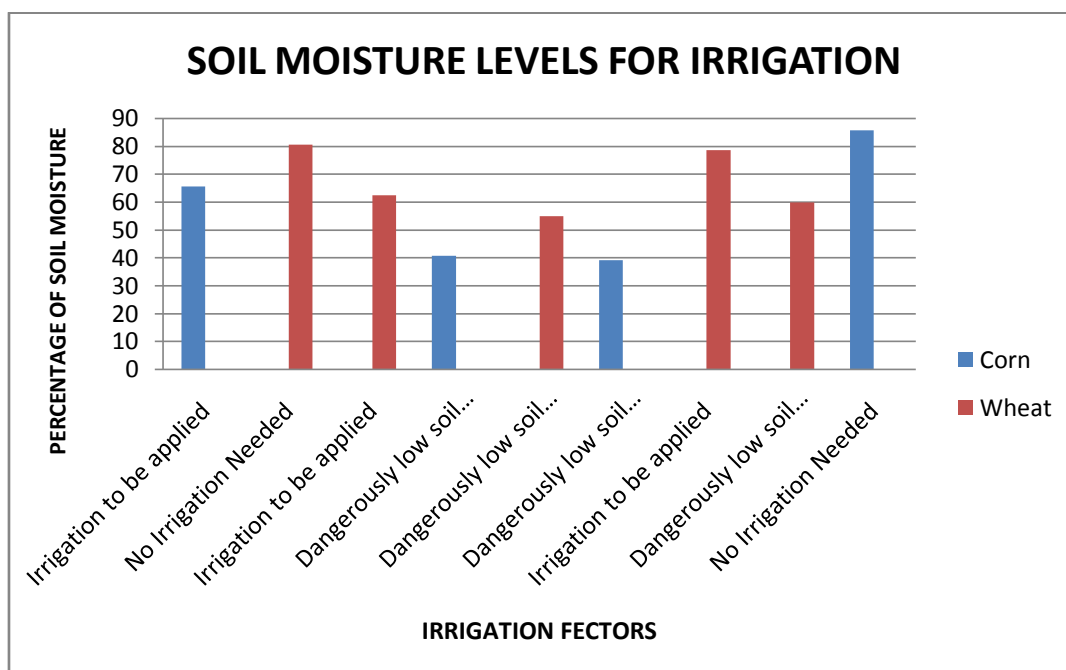

Fig. 7: Real Time values of soil moisture of Corn and Wheat corps based on irrigation factors

Table 3: Real Time values of soil moisture of Corn and Wheat corps based on irrigation factors

Irrigation Factors	Corn	Wheat
No Irrigation Needed		90.25
Dangerously low soil moisture		59.87
Irrigation to be applied	69.85	
Irrigation to be applied		74.25
Irrigation to be applied	65.85	
Irrigation to be applied		78.95
Irrigation to be applied		69.85
Irrigation to be applied	60.7	
Irrigation to be applied		64.03

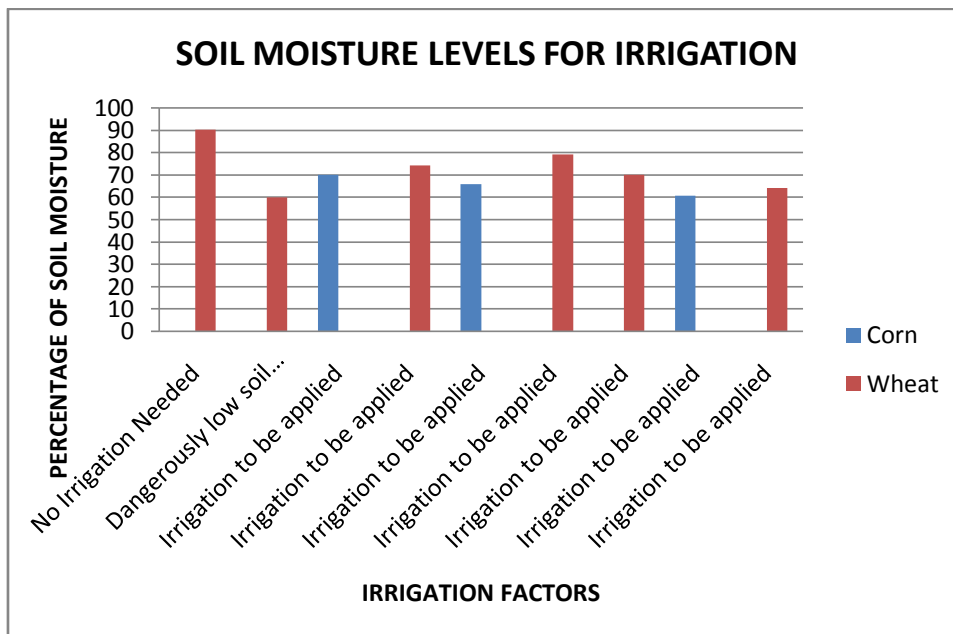

Fig. 8: Real Time values of soil moisture of Corn and Wheat corps based on irrigation factors

IX. CONCLUSION

The proposed methodology helped in collecting the parameters present in the soil using different sensors by taking the help of the Arduino. The collected information is then used for soil type prediction. The proposed methodology is being used to design the soil monitoring system for measurement and control of the plant growth parameter, i.e. soil moisture. The data which we get from the measurement has shown that the system performance is quite dependable and correct. Soil moisture sensors are used in detecting the changes which are required and to calibrate irrigation practices. These minor changes in irrigation practices help in increasing yield and saves water. The lead to proper irrigation management using soil moisture sensors

is disciplined monitoring of the sensors to get the soil moisture level when the data obtained is in the determined range for the specific soil type. With the use of IoT Devices and Soil Moisture sensors we can use the same to predict seasonal variations which can also help the farmers to plan their future harvest which can be future work on this research. However, our system abolishes the snag of the current set-ups. It is proving to be a simple to use, flexible and economical.

REFERENCE

- [1] Noramalina Abdullah¹, Noor Aerina Durani, Mohamad Farid Shari, Siong King Soon, Vicky Kong Wei Hau, Wong Ngei Siong and Khairul Azman Ahmad, "Towards Smart

- Agriculture Monitoring Using Fuzzy Systems”, IEEE ACCESS 2017.
- [2] BhaveshRathod, GautamHavaldar, VaibhaviPandit, Vikram Bhatia, “Sub-1 GHz Based Solar Powered Soil MoistureSensing Network”, International Research Journal of Engineering andTechnology (IRJET), Page 3372, 5(04),2018.
- [3] Ravi Kishore Kodali, ArchanaSahu, “An IoT Based Soil Moisture Monitoring on Losant Platform”, IEEE 2016.
- [4] Ravi Kant Jain, Bikash Gupta and Mustaq Ansari, ParthaPratim Ray, “IOT Enabled Smart Drip Irrigation System Using Web/Android Applications”, 11th ICCCNT 2020 July 1-3, 2020 - IIT – Kharagpur.
- [5] Madhumathi R., Arumuganathan T, Shruthi R, “Soil NPK and Moisture analysis using Wireless Sensor Networks”, 11th ICCCNT 2020 July 1-3, 2020 - IIT – Kharagpur.
- [6] Dr. Ayyasamy S, Eswaran S, Manikandan B, Mithun Solomon S P, Nirmal Kumar S, “IoT based Agri Soil Maintenance Through Micro-Nutrients and Protection of Crops from Excess Water”, ICCMC 2020.
- [7] Rama Chidambaram RM, VikasUpadhyaya, “Automation in drip irrigation using IOT devices”, 2017 Fourth International Conference on Image Information Processing (ICIIP)