

# Power Quality Enhancement By Using Dc-Dc Zeta Converter

Bindra Dawar<sup>1</sup> and Prashant Kumar<sup>2</sup>

<sup>1</sup>Assistant Professor, Ujjain Engineering College, Ujjain, M.P

<sup>2</sup>Prashant Kumar, SVNIT, Surat

Submitted: 01-08-2021

Revised: 10-08-2021

Accepted: 15-08-2021

**ABSTRACT:** This work presents the implementation of the switch-mode power supply for power quality improvement by maintaining the power factor within the acceptable limit. In this paper, dc-dc converter zeta converter is implemented to achieve the voltage regulation in the dc output voltage of zeta converter that is being fed to the high-frequency transformer with help of high value of capacitors to get the multiple output dc voltage. The system starts with ac supply which is fed to the rectifier circuit to get the dc voltage followed by filter circuit to neglect the distortions, further it is given to the zeta converter which is operated in discontinuous conduction mode (DCM) in which output inductor is operated in DCM in one switching cycle gives the best result among the several operating modes suitable for SMPS. This test result of zeta converter with SMPS is achieved in MATLAB Simulink as well as corroborated with the hardware implementation.

**KEYWORDS:** Zeta Converter, High-Frequency Transformer, Power Factor Correction, Switch Mode Power Supply, Total Harmonic Distortion

## I. INTRODUCTION

All Switch-mode power supply (SMPS) is finding the applications in personal computers (PCs), arc welding power supply, mobile phone chargers, security system (closed-circuit cameras), support supplies with PLC's, aircraft communication system etc. there is large distortions which leads to the high total harmonic distortion (THD) in existing system so it needs to be replaced with an efficient system to improve total harmonic distortion (THD) in ac mains. The switch-mode power supply has many applications in the personal computer, arc welding, etc. The switch-mode power supply is the best choice for DC-DC converter used in the computer which converts available unregulated ac to regulate multiple dc voltage to provide power to different parts of computer [1]. It is also used for arc

welding power supply which draws highly distorted current with low power factor so to enhance the efficiency zeta is implemented [2]. Among the entire dc-dc converter topology zeta converter is 4th order which is a combination of the buck-boost converter which provides less pulsating current [3]. The zeta converter is mainly adapted to reduce the total harmonic distortions (THD) in line current which improves the pulsating current in the input side of it [1],[3]. The power factor improvement of the converter is achieved by designing power factor correction (PFC) circuit and be placed in front of the converter [4]. The main motive is to minimize total harmonic distortion (THD) as per the IEEE 519 in the ac mains by implementing the power factor corrected (PFC) zeta converter for multiple output switch mode power supply (SMPS) circuit.

**Methods/Statistical analysis:** The power factor improvement of the converter is achieved by designing power factor correction (PFC) circuit and be placed in front of the converter. The system consists of converting single phase ac supply voltage into multiple output dc voltages. In this work, non-isolated zeta converter which is dc-dc converter is operated in various modes from which best selection mode of operation is done which are suitable for many industrial applications. Another converter is cascaded with zeta converter to convert one level of voltage into multiple levels of dc voltages.

**Findings:** The performance of the zeta converter for its components operating in discontinuous conduction has been analyzed. Among them, output inductor in DCM gives good performance to the application with reduced total harmonic distortions (THD) (less than 5%) and regulated dc output voltage with wide variations in input operating voltage. Application/Improvements: Optimization of THD level with less than 5% and

smoothly regulated the dc voltage for a wide variation in input voltage.

## II. SYSTEM CONFIGURATION

Figure 2 shows the system of power factor corrected zeta converter employing to the switch mode power supply (SMPS). The system consists of the diode bridge rectifier to convert the ac supply to DC with L-C filter to make ripple-free dc. This dc voltage is feed to the front-end zeta converter. Zeta converter is operated in a different mode of operations in discontinuous conduction. The advantage of the discontinuous mode of operation is the reduction of voltage and current sensing devices also reduces the stresses on the devices and saturation problem. PCs need one voltage sensor for sensing as well as a control so the discontinuous mode of operation is preferable [5], [6]. Zeta converter consists of input and output

inductors with an intermediate capacitor, diode and high-frequency switch. The next stage of the filter circuit is a zeta converter which is the mediator between ac supply and SMPS circuit. It is operated in three different modes of operation with making its one of the components from  $L_1$ ,  $L_2$ , and  $C$  in discontinuous conduction. The best operating mode is considered for PFC ZETA converter among them. Voltage is regulated by regulating the duty cycle of the converter. This regulated dc voltage is being given to the isolated converter. Multiple output dc voltage is driven from the isolated converter which is consisting of two capacitors and high-frequency transformer. Multiple outputs are driven from the isolated converter from which one is directly sensed while other output voltages are controlled by the duty cycle.

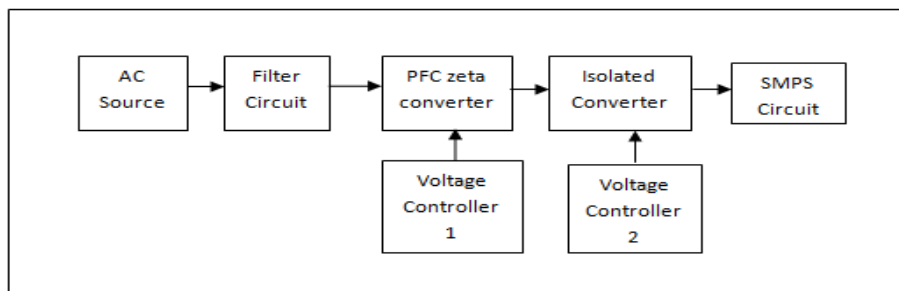


Fig.1. Block diagram of SMPS

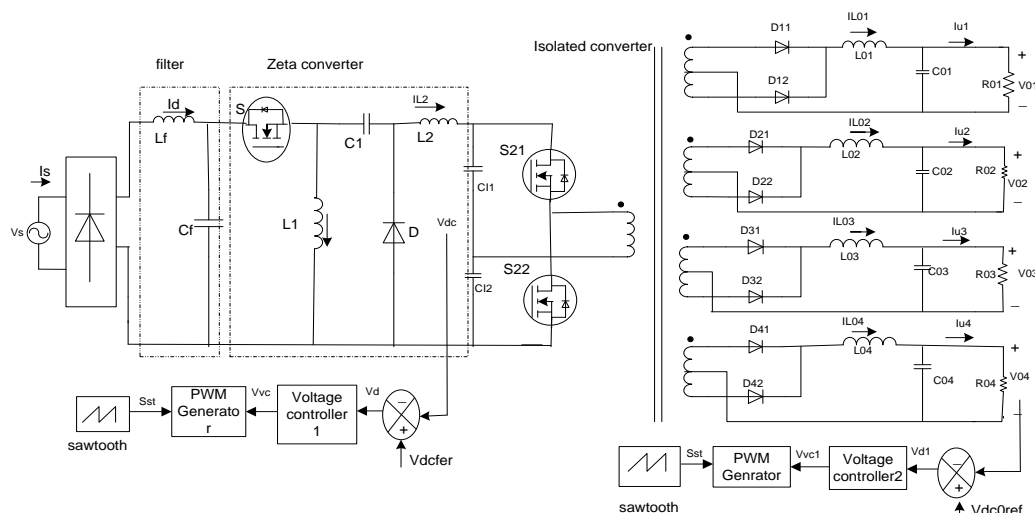


Fig.2. Zeta converter for SMPS circuit

## III. MODE OF OPERATION

### 3.1. Input Induction is in DCM

In the output, an inductor is non-zero in one switching cycle. Operated as  $L_1$  in

discontinuous and  $L_2$  with  $C$  in continuous mode. This mode is operated in three stages [7]. The Stages are as follows.

### 3.1.1. Stage 1

Initially current in the two inductor components rises with capacitor voltage becomes low. Realization of the switching state of each component.

### 3.1.2. Stage 2

In this condition diode D free wheels, the energy to the capacitor which in turn increases the voltage across it while the rate of change of current to both inductors is almost zero.

### 3.2.3. Stage 3

The actual realization of the first mode of operation which deals with the discontinuous state of  $L_1$ . Also, switch and diode are off in this state for one switching cycle and waits for the next PWM cycle.

### 3.2 Capacitor is in DCM

Zeta converter is in operation with the middle capacitor C is in discontinuous conduction mode in one switching cycle which makes other two inductors is in CCM. This mode is operated in three stages. The Stages are as follows.

#### 3.2.1. Stage 1

The input and output inductor  $L_2$  are in charging the state with capacitor C is in discharging when the switch is on. During this state output capacitors  $C_{11}$  &  $C_{12}$  voltage increases.

#### 3.2.2. Stage 2

#### 3.3.3. Stage 3

In this interval, both switch S and diode D is off. Output inductor does not revolt with a current at all ensuring DCM of  $L_2$ .

## IV. DESIGN SPECIFICATION OF ZETA CONVERTER

Design of zeta converter is based on various components as input inductor, middle capacitor and output inductor. Each component is calculated with the duty cycle of the converter. As well as zeta converter buck, boost, converters can also be employed for dc-dc conversion among all zeta provides the efficient result [6]. This duty cycle is calculated as,

$$L_1 = \frac{V_d^2}{2P} \left[ \frac{V_{dc}}{V_s + V_{dc}} \right] \quad (1)$$

$$= \frac{50\mu s (153.1V)^2}{2 \times 350W} \left[ \frac{300V}{(1.414 \times 170 + 300V)} \right]$$

$$= 0.92 \text{ mH}$$

$$C_1 = \frac{V_{dc} \times T}{2(V_{dc} + V_s)^2} \quad (2)$$

The energy input to one of the inductors increases while the other output inductor component decreases in this stage of operation. The isolated converter is supplied with the  $L_2$  of the zeta converter with zero voltage of the capacitor.

### 3.2.3. Stage 3

In this state, continuous conduction is made. The energy in the  $L_1$  and  $L_2$  which is the components of zeta converter decreases by some of more amounts. And a capacitor of zeta is supplied with more amount of voltage.

### 3.3. Output Inductor is in DCM

In one switching cycle three different states have been analysed when output inductor  $L_2$  is in DCM and input inductor  $L_1$  and capacitor C is in CCM. Which provides the desired of operation zeta converter. This mode is operated in three stages. The Stages are as follows.

#### 3.3.1. Stage 1

During this state both inductors  $L_1$  and  $L_2$  are in charging mode with switch S is ON and the voltage across the capacitor decreases.

#### 3.3.2. Stage 2

In this stage diode D free wheels energy across the capacitor dc-dc converter. While the amount of energy of two other components decreases by more amounts. Current  $i_{L1}$  becomes equal to the negative of current  $i_{L2}$  in this state.

$$= \frac{50\mu s \times 350W}{2(300V + 270 \times 1.414)^2}$$

$$= 18.824 \text{ nF}$$

$$L_2 = \frac{V_d^2 V_{dc} T}{\Delta I_s} \left[ \frac{V_{dc}}{V_s + V_{dc}} \right] \quad (3)$$

$$= \frac{(153.15 \times 153.15) \times 300V \times 50\mu s}{0.5 \times 2.05 \times 1.414} \left[ \frac{300V}{170 \times 1.414 + 300V} \right]$$

$$= 1.15 \text{ mH}$$

Whereas  $V_{dc}$  is first stage converter output voltage. Values of the components of zeta converter are calculated with RMS supply voltage, a dc output voltage of zeta converter and input power 350 w and duty cycle for CCM and DCM. Currently, the use of low power application has been increased for which we require supply which is distortion-free so we use converters which operates in discontinuous mode [7]. In DCM the values are as follows,

$$L_1 = \frac{V_s T}{\Delta I_s} \left[ \frac{V_{dc}}{V_s + V_{dc}} \right] \quad (4)$$

$$= \frac{1.441 \times 170 \times 50 \mu s}{0.50 \times 2.50 A \times 1.414} \left[ \frac{300V}{1.414 \times 170V + 300} \right]$$

$$= 4.603 \text{ mH}$$

$$C_1 = \frac{\alpha T V_{dc}}{2 \Delta V_{c1} R} \quad (5)$$

$$= \frac{T V_{dc}}{2(\Delta(V_{dc} + V_s)) \left( \frac{V_{dc}^2}{P_{in}} \right)} \left[ \frac{V_{dc}}{V_s + V_{dc}} \right]$$

$$= \frac{T P_{in}}{2(\Delta(V_{dc} + V_s))(V_{dc} + V_s)}$$

$$= \frac{50 \mu s \times 350 w}{2(0.3(300V + 270 \times 1.414))(300V + 270 \times 1.414)}$$

$$L_2 = \frac{V_{dc} T}{\Delta I_s} \left[ \frac{V_{dc}}{V_s + V_{dc}} \right] \quad (6)$$

$$= \frac{300V \times 50 \mu s}{0.5 \times 2.05 A \times 1.414} \left[ \frac{300V}{170 \times 1.414 + 300V} \right]$$

$$= 5.7456 \text{ mH}$$

## V. ISOLATED CONVERTER

It is an obvious condition in the converters that it should get controlled to achieve the regulated output conditions. The PIC Microcontroller is used for switching purpose for both the converters that are Zeta converter and the isolated converter.

### 5.1 Control of Power Factor Corrected Zeta Converter

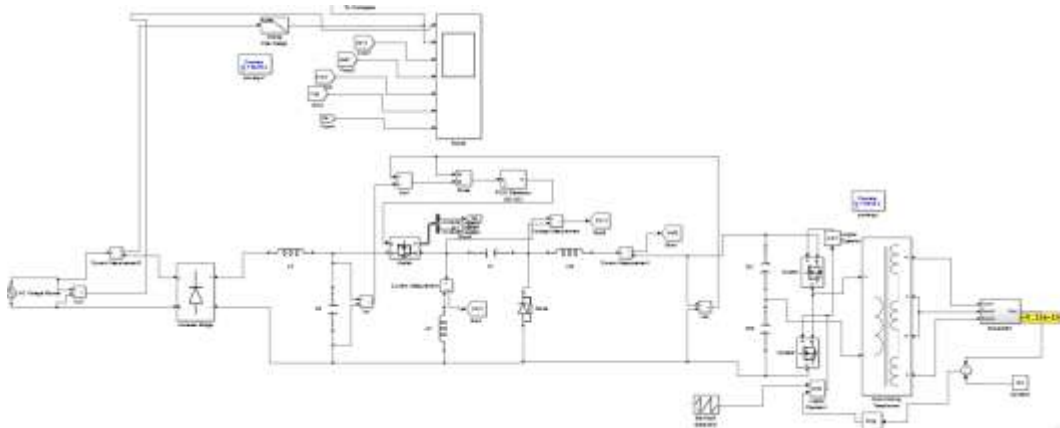
In this converter, the selected controller generates the gate pulses by using the drive circuit. It mainly consists of comparing the generated output voltage with the reference voltage. After comparing the voltages, the error signal is generated and this error signal is passed over the PWM (pulse width modulation) generator with the inclusion of the saw-tooth signal.

$$V_e = V_{dcref} - V_{dc} \quad (7)$$

Whereas  $V_e$  is error voltage signal which is feed to the controller that generates the dc output voltage.

## VI. SIMULATION RESULTS OF ZETA CONVERTER

Figure 6.2 shows the total simulation model of the zeta converter implemented for switch mode power supply.



6.1.  $L_1$  of Zeta Converter is in Discontinuous Conduction

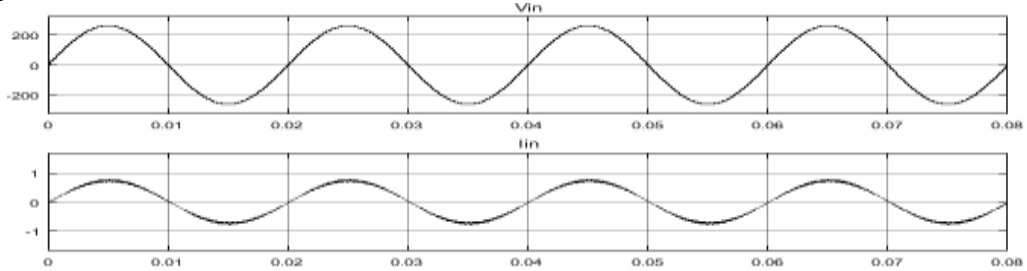


Fig.3. Modelling of zeta converter in MATLAB/Simulink

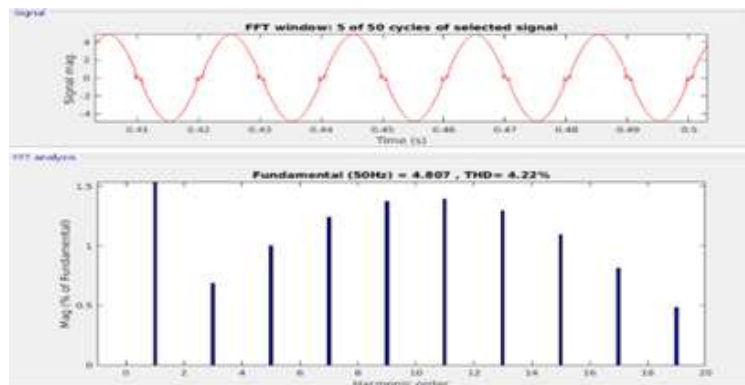
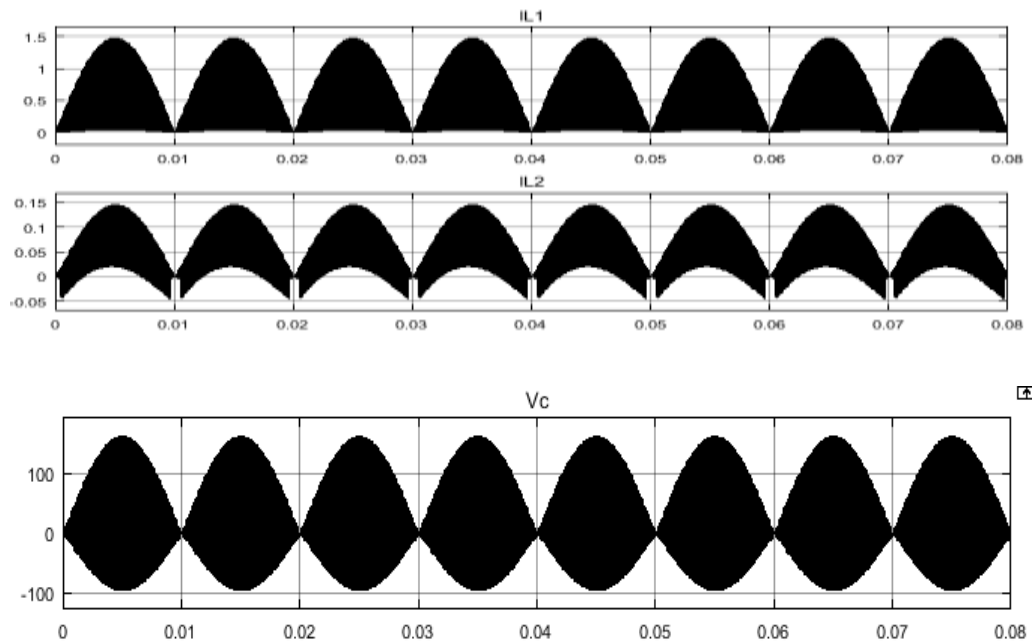
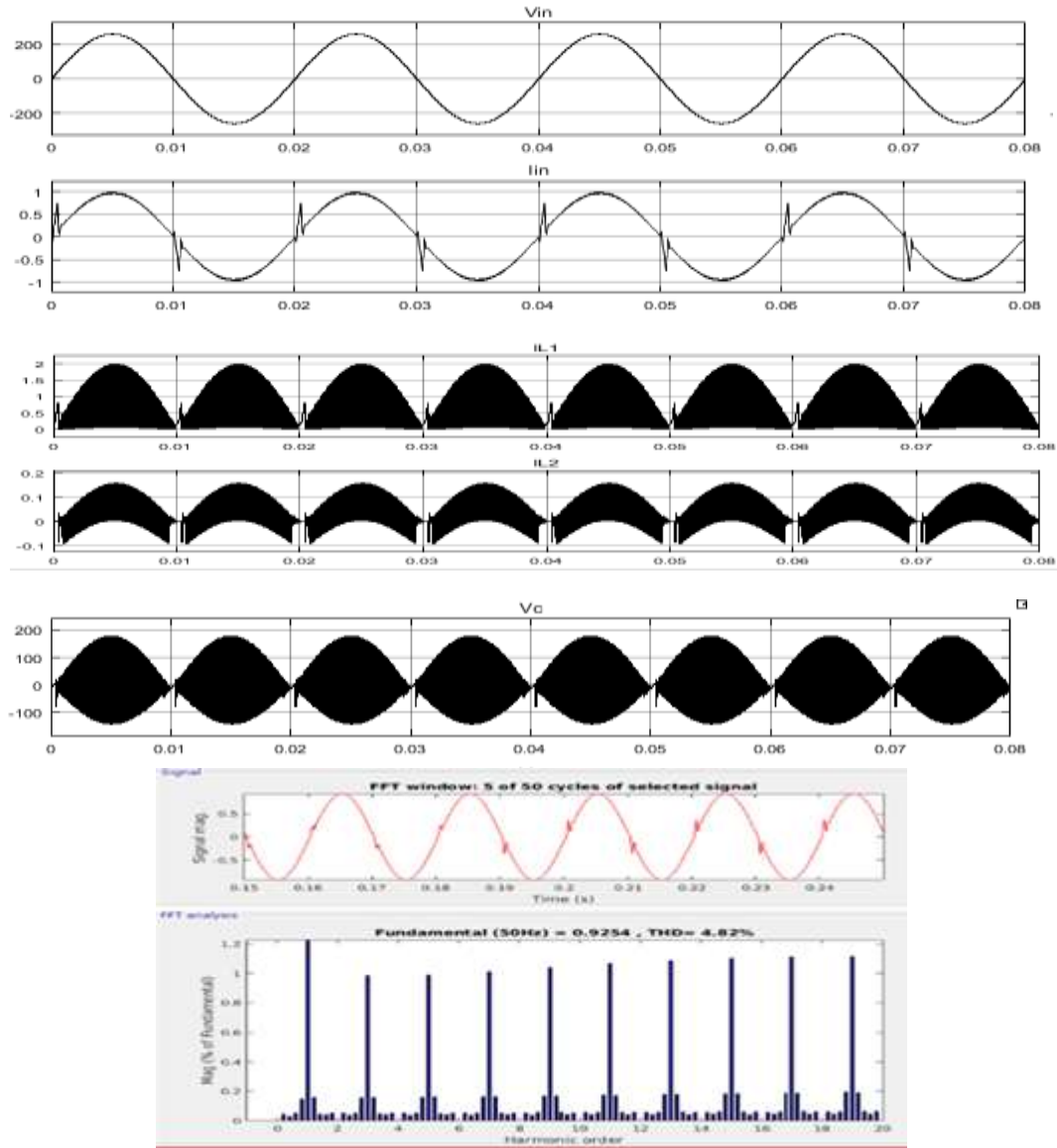


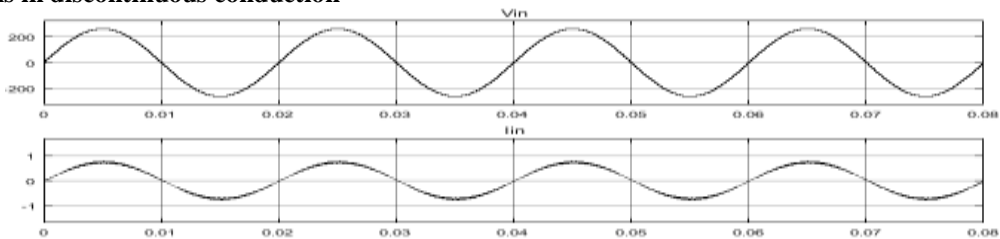
Fig.4. The output waveform of components zeta converter with  $L_1$  is in DCM with its harmonic spectrum.

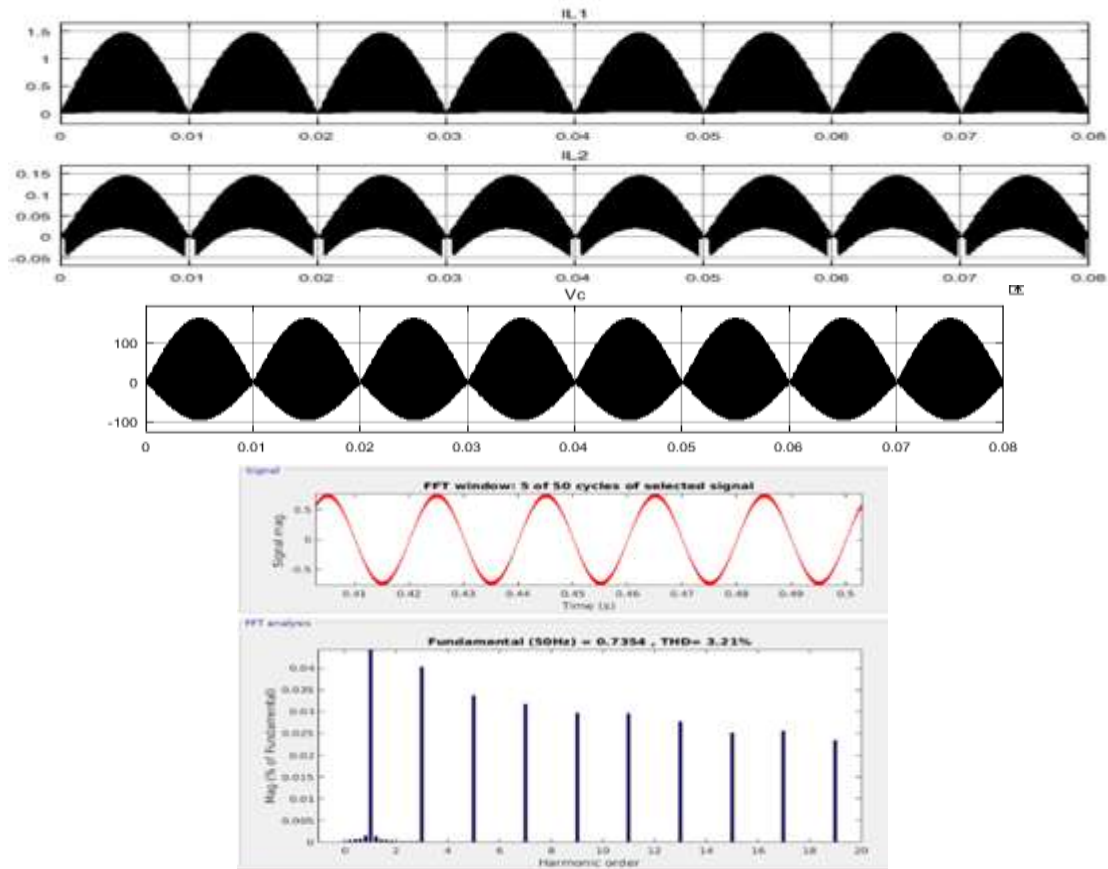
**6.2. C of Zeta Converter is in Discontinuous Conduction**



**Fig.5.** The output waveform of components zeta converter with  $C_1$  is in DCM with its harmonic spectrum.

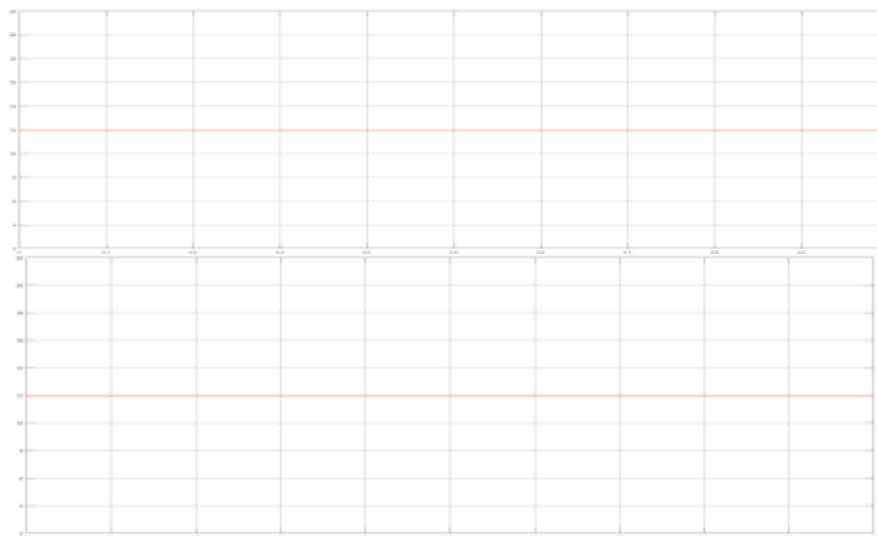
**6.3.  $L_2$  is in discontinuous conduction**

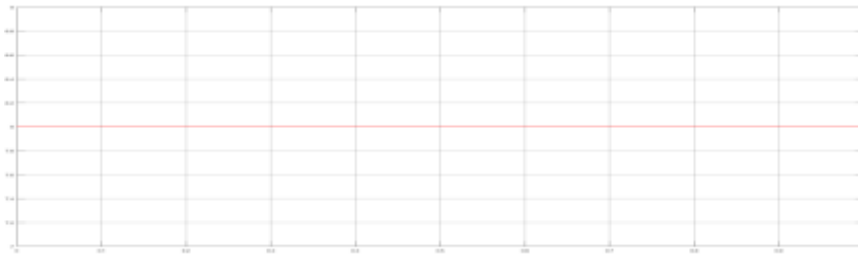




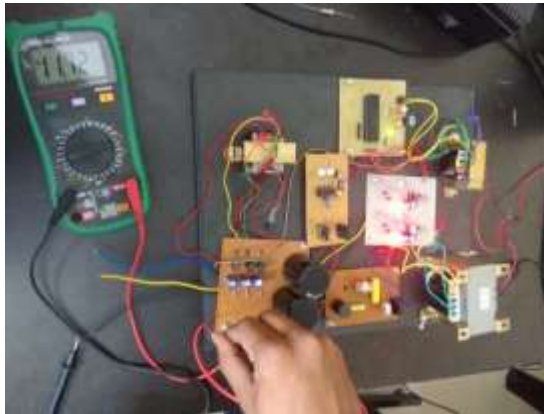
**Fig.6.** The output waveform of components of the zeta converter with  $L_2$  is in DCM with its harmonic spectrum.

#### 6.4. Results of Multiple Output DC voltage

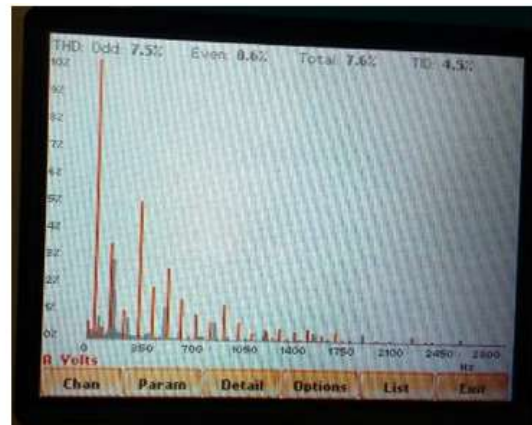
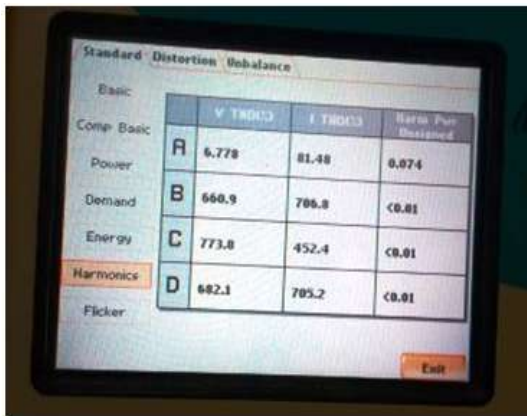




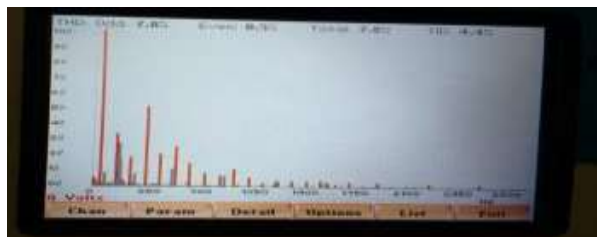
1 **VII. HARDWARE IMPLEMENTATION OF ZETA CONVERTER WITH SMPS  
 CONVERTER WITH SMPS**



**Fig.7.** Validation of result with hardware implementation



**Fig.8.** Validation of Voltage THD 6.7 % with hardware. **Fig.9.** Validation of Current THD 4.5% with hardware.



**Fig.10.** Validation of Current THD 4.4% with hardware



## VII. CONCLUSION

A DCM (Discontinuous conduction mode) operated zeta converter cascaded with multiple output isolated converter has been used for the implementation of an SMPS for PCs. It has been modelled, simulated and developed for input power quality improvement and output voltage regulation. All the dc output voltages are regulated by controlling one output voltage and other output voltages are controlled by the duty cycle of the isolated converter. Three discontinuous conduction modes of operation of the zeta converter elements have been carried out in simulation to select the best possible operation. The output inductor of zeta converter operating in discontinuous mode is selected as input to the isolated converter. Finally, the best-suited mode of operation of the zeta converter has been implemented in a hardware prototype. From the recorded test results, it is evident that the proposed power supply can mitigate power quality problems that are present in the conventional SMPS systems. Based on these results, it is concluded that the designed SMPS configuration for PCs gives 4.5% THD of ac mains current under a wide range of input voltage. The performance of the zeta converter has proven its performance efficiency in the MATLAB platform.

## ACKNOWLEDGEMENTS

I wish to thank Prashant Kumar, and my parents, who provide unending inspiration.

## REFERENCES

- [1]. Bhim Singh, G. Bhuvaneswari, "Power Factor Corrected Zeta Converter Based Improved Power Quality Switched Mode Power Supply" IEEE Transactions on industrial electronics, vol. 62, no. 9, September 2015.
- [2]. Swati Narula, G. Bhuvaneswari "Modular Zeta Converter Based Power Quality Improved SMPS for Arc Welding".
- [3]. D Bnisur Cruz Martins "Application of The Zeta Converter in Switched Mode Power Supplies" IEEE Power Convers. Conf., Apr. 1993, pp. 147–152.
- [4]. D.P. Symanksi" Distribution Circuit Power Quality Considerations for Supply to Large Digital computer loads" IEEE Transactions on Power Apparatus and Systems, Vol. PAS-100, No. 12 December 1981.
- [5]. Bernhard Wicht Robert Bosch Center for Power Electronics Reutlingen University "A 120/230 Vrms-to-3.3V Micro Power Supply with a Fully Integrated 17V SC DCDC Converter" IEEE 2016.
- [6]. Geoffrey R. Walker "Cascaded DC-DC Converter Connection of Photovoltaic Modules" IEEE Transactions on power electronics, vol. 19, no. 4, July 2004.
- [7]. Joseph W. Spencer" Analysis of Boost PFC Converters Operating in the Discontinuous Conduction Mode" IEEE Transactions on Power Electronics, Vol. 26, No. 12, December 2011.