

# Sustainable Energy-Nitrogen Based Thermal Energy Storage and Heat Recovery System for Sustainable Electrical Power Generation

Valentino Joebert Barbosa

*BE in Mechanical Engineering – (VTU-Belgaum), M.tech Manufacturing Mangement( BITS-PILANI), PGD. Marine ( SIMS-Lonavla), Associated Member of Institute of Engineers, INDIA, Address: Macbrou Engineering Pvt Ltd, 120/1-B , Margao Industrial Estate , Nessai , Salcete , Goa-INDIA 403705.*

Submitted: 01-03-2022

Revised: 07-03-2022

Accepted: 10-03-2022

**ABSTRACT:** Limited resources to Sustain Human life are depleting day by day and its almost irreversible damage we are causing to the very own home we live in, the Earth. Energy is the important driver of highly transitional technological change we are going on to driving huge economies and shaping lives thus adding comfort to life but the question is “how long?”. Sustainable Development Goals Speak about Clean and Affordable Energy but do we have enough resources for the future? How can we Harness the energy and are there renewable sources of energy? Can we meet our zero emission targets? At the End of this paper, we will be able to answer all this questions. This research will focus on sustainable Production of Electrical Energy from renewable low heat energy sources and recover waste heat from low temperature heat sources. Efficient Utilisation of Energy without Carbon Emissions will drive us to sustainable Electrical Energy for All making it cheaper, more efficient, Reliable, Controlled and yet environment friendly. Thermal Energy Storage Systems will include Cryogenic Energy Storage systems and High Temperature Molten Salt Storage Systems the temperature difference across these systems will be vaporise Nitrogen which will drive expansion turbine coupled with alternator to generate electricity. We shall simply call it Nitrogen Engine which will be used to recover heat energy from Various sources such as Geothermal, Ocean Thermal, Heat Pumps, Cryogenic Fluid Boil off, Solar Radiation and may be even from hot air. Part of the research would also look at Development of Expansion Turbines, Active Magnetic Bearings, Cryogenic Turbo Expanders

and Turbo Alternators, Nitrogen Boiling systems, Alternator Braking System in fact the whole Nitrogen Engine to recover the Heat Energy. Available Technologies Shall be incorporated and integrated to develop the complete thermal and Electrical Energy Management system which would be intelligently controlled using the modern technology making it extremely smart and responsive to our Energy needs of the future.

Keywords: Thermal Energy Storage, Nitrogen Engine, Heat Recovery, Renewable Energy, Sustainable Energy, Environment, Low Energy

## I. INTRODUCTION:

Energy Crises has been problem for ages and is a socio-economic problem, restricted supply with diminishing availability has led to inflated prices. Rising population and high waste generation rates has been a posing challenge to the limited resources in hand. Manufacturing Industries and Commercial Complexes account for the Majority of Waste generation and Energy Consumption. The demand for Energy has further geared up due to globalisation and digital transformation. Worldwide, the energy consumption of manufacturing industries grew by 61% from 1971 to 2004 and accounts for nearly a third of today's global energy usage. Likewise, they are responsible for 36% of global carbon dioxide (CO<sub>2</sub>) emissions (IEA, 2007). Increase Energy Demand has caused serious inflation in prices of almost all goods and further has left devastating effects on our environment. While Every Living and Non-Living Matter on earth contributes towards impact on environment human beings have caused

devastating and tremendous negative impact on the environment. Pollution is simply the introduction of hazardous contaminants into the environment which would be chemical, Physical, Biological or even inform of noise or light which causes ecological unbalance in the system. It has been estimated that about 400 million metric tons of pollution is produced annually, of which the United States alone produces 250 million metric tons, having only 5% of the global population US alone produce quarter of carbon emissions across the globe and the impact is simply devastating. "Climate change is already affecting every inhabited region across the globe," affirms the first instalment of the IPCC AR6. Prepared by 234 scientists from 66 countries, this report examines the extent to which changes are occurring on Earth's land, oceans, and atmosphere – its biosphere. Their conclusions deem it "unequivocal" that human influence has contributed to global warming, finding that approximately 1.1 degrees Celsius warming can be attributed to emissions of GHGs from human activities. Based on observational data of historical warming from 1850 to 2020, global temperature will reach or exceed 1.5 degrees Celsius warming

in the coming decades. The report mentions that emissions of carbon dioxide (CO<sub>2</sub>), a GHG and main driver of climate change, are also negatively impacting coastal areas and oceans. Coastal areas will continue to experience sea level rise during this century, contributing to flooding and coastal erosion. The authors state that oceans are also experiencing warming, acidification, and reduced oxygen levels largely due to increasing global temperature and increased absorption of CO<sub>2</sub>.

Increasing Carbon Emissions and unstructured policies has led to dramatic effect on the environment. Rapid Ramping up of Production in Manufacturing Facilities and fast-growing economies have further contributed to unsustainable development of frameworks which have further stirred up alarming Environmental crises stemming from ever increasing Greenhouse gases, Industrial wastes and contaminants and Natural resource Depletion. As a result, reducing carbon emissions has become absolute necessity which has further geared up a need for an imperative tool – Zero Emission systems and waste management in this long-lasting battle against climate change, ecological balance, Economic Environmental and health disruptions.

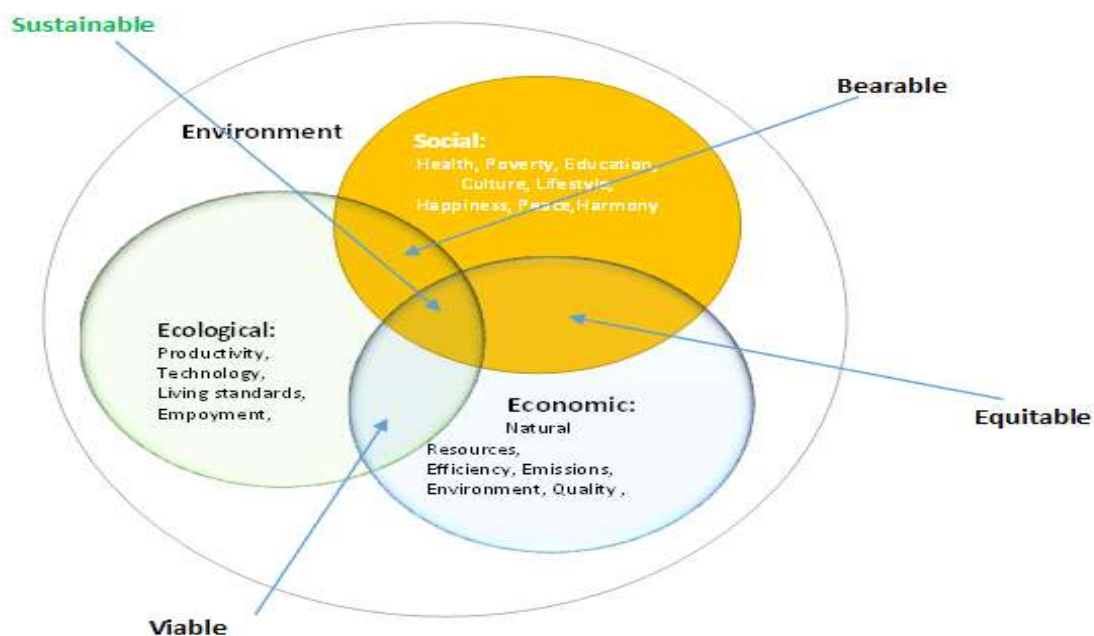

Figure 1 : 3 Pillars of Sustainability bounded by the environment.

Increasing Carbon Emissions and Rising Demand for Energy has left no choice but to look for Alternative sources of energy other than hydro-carbons. One such Alternative which this paper focusses on is low heat sources where the

temperature range of such sources is between 20 deg C to 80 deg C. As per the 1<sup>st</sup> Law of thermodynamics or the Law of Conservation of Energy states that "heat is a form of energy, and thermodynamic processes are therefore subject to

the principle of conservation of energy. This means that heat energy cannot be created or destroyed. It can, however, be transferred from one location to another and converted to and from other forms of energy.” Now the Most viable form of energy which can be easily Stored, transported with minimum losses is electrical Energy. So we shall be looking at harnessing heat from low heat systems by using heat pumps with Nitrogen as the working Media where the generated heat isothermally expand nitrogen which will in turn drive turbo-expander which would either help in compressing refrigerant or can be coupled with an alternator to generate electricity. The low Heat Sources can be either from Geothermal Sources, Solar Heat, and Hot Air or from the industrial processes. We shall theoretically explain the complete system with their respective components in the system.

**Objectives of the study:** The Objective of this study is to produce electrical energy in a sustainable way by harnessing energy from low temperature heat sources (Sun, Geothermal Hot Air or Process waste heat). Since this Sources are renewable in easily be harnessed from nature and

are almost available everywhere on earth they will be practically viable to be used anywhere thus bringing the overall cost of production, Distribution and usage of energy down without harming the environment. The same Concept Shall be applied to harness industrial process heat and also we shall be using the waste heat from Industrial Utilities such as Air Compressors, Heat Pumps , HVAC equipment etc. thus improving resource efficiency and mitigating the rising demand of energy. The Objectives are as follows:

- Sustainable Production of Electrical Energy to meet the increasing demand of energy.
- Waste Heat Utilisation and improving overall system Efficiency.
- Reducing Carbon Emissions across the Energy Supply Chain.
- Making Energy Affordable.
- Minimising Impact on Environment and preserving life.
- Generating power without Effecting Life on earth.
- Affordable Remote Energy Generation.
- Meeting the Net Zero Emission Targets.
- Meeting SDGs in Energy Production



Figure 2: UN Sustainable Development Goals. Source: Internet.

**Hypothesis and System Design :** The First Law of Thermodynamics: The law of conservation of energy states that the total energy of any isolated system (for which energy and matter transfer through the system boundary are not possible) is

constant; energy can be transformed from one form to another, but can be neither created nor destroyed. We shall be using Nitrogen as the Working Fluid as it expands 710 times between its liquid to gas phase change. Also, its very important to note that the

critical point of Nitrogen -146.96 and 33 bar and this will be important while designing the nitrogen Engine. That's Not All Nitrogen cover 78% of Earth's Atmosphere and presently we have the

technology to raise the Thermal Potential by liquification of Nitrogen. We can call it cryogenic Energy Storage.

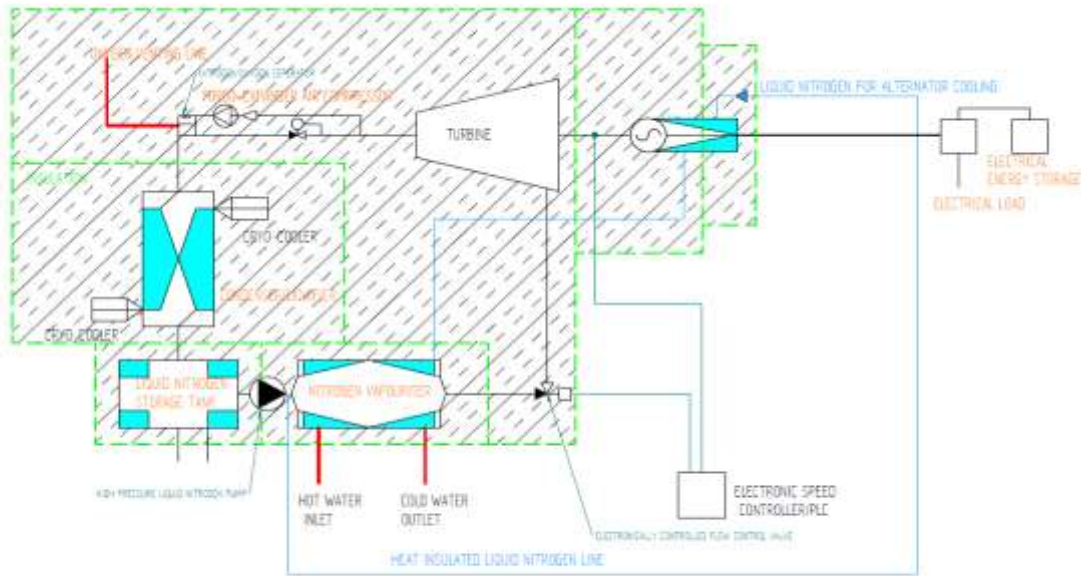

NITROGEN ENGINE -LOW HEAT TO ELECTRICAL ENERGY

Image 0: Nitrogen Engine -Layout

Nitrogen phase diagram

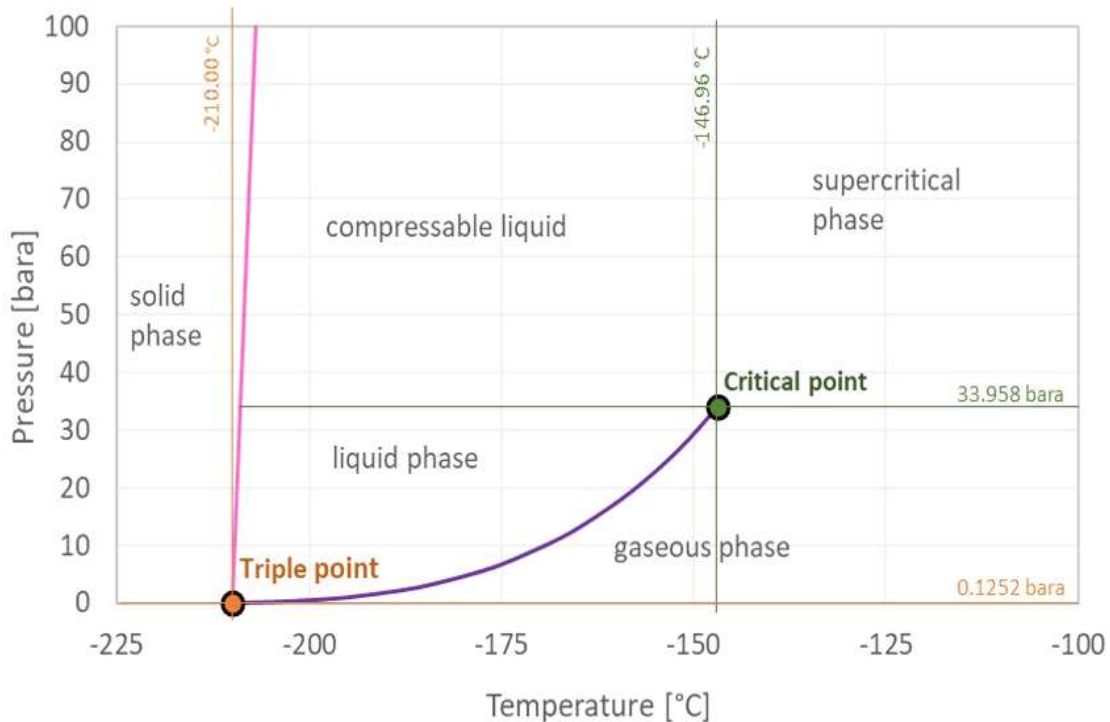

Figure 3: Nitrogen Phase Diagram



The Properties of Nitrogen as Follows:

<b>Element:</b>	<b>Nitrogen</b>	<b>Electron Conf.</b>	[He] 2s <sup>2</sup> 2p <sup>3</sup>	<b>Melting Point</b>	-209.9 °C
<b>Symbol:</b>	N	<b>Oxidation States</b>	+1,2,3,4,5/-1,2,3	<b>Boiling Point</b>	-195.8 °C
<b>Atomic Number:</b>	7	<b>Electron Affinity</b>	7 kJ/mol	<b>Th. Conductivity</b>	0.02598 W/m K
<b>Element Category:</b>	Non-Metal	<b>Electronegativity</b>	3.04	<b>Specific Heat</b>	1.04 J/g K
<b>Phase at STP:</b>	Gas	<b>Ionization</b>	14.5341 eV	<b>Heat of Fusion</b>	(N <sub>2</sub> ) 0.7204 kJ/mol
<b>Atomic Mass [amu]</b>	14.0067	<b>Discovery</b>	1772	<b>Heat of Vap.</b>	(N <sub>2</sub> ) 5.56 kJ/mol
<b>Density at STP</b>	1.251 g/cm <sup>3</sup>	<b>Discoverer</b>	Rutherford, Daniel	<b>Crystal Structure</b>	hexagonal

Table 1: Chemical Properties of Nitrogen at Atmospheric Pressure.

The Biggest Technological challenge is to harness the waste heat from low temperature sources and convert it to Electrical Energy thus in turn reducing the Atmospheric temperature on larger scale when coupled with Heat Pumps and generating electricity at the same time. Now Water would be the next working Media for Low temperature Heat Transfer to High Pressure gas.

available for filtering the compressed air and removing the 21% of oxygen and this is simply because of difference in the size of molecules this atom possess. To generate Nitrogen from atmospheric air we will need an Air Free Compressor, An Air Drier to remove the moisture and the condensing fluids (In this case we shall be using a desiccant drier) and a Nitrogen Filter and a Storage Tank as Show Below:

**Nitrogen Generation Systems:** Based on the purity of Nitrogen Gas required nitrogen filters are

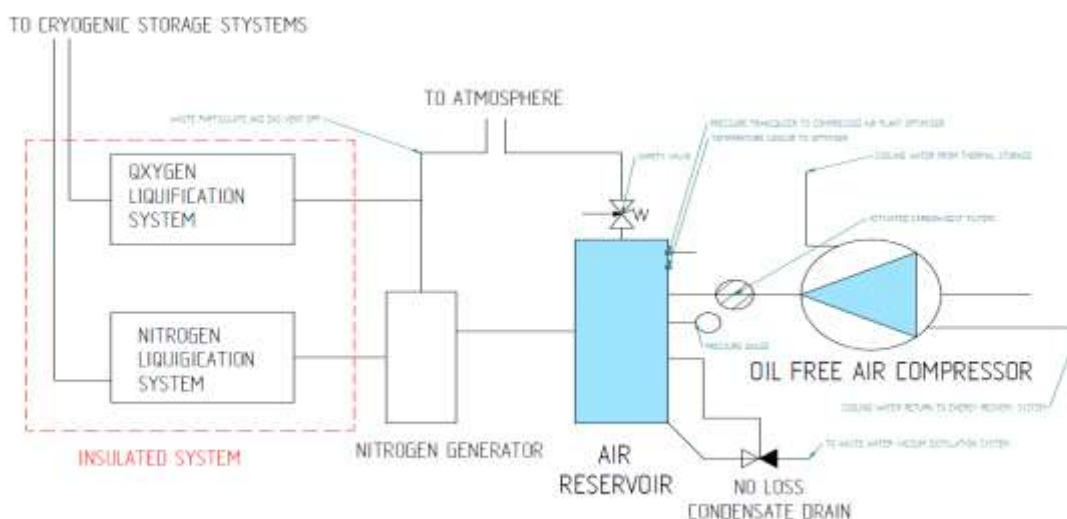

Figure 4: NITROGEN GENERATION AND STORGAE SYSTEM

**Oil Free Compressors:** We Shall be using water injected oil free compressor to optimise our CAPEX value from ATLAS COPCO ( [AQ Compressors - Atlas Copco India](#) ). When it comes to clean, oil-free compressed air, you cannot afford

to compromise on quality. Over the past decades, Atlas Copco has pioneered oil-free water-injected screw technology, resulting in a broad range of compressors delivering 100% oil-free, clean air. Setting the standard through ISO 8573-1 CLASS 0

certification, the AQ meets your need for pure oil-free air while offering best in class energy efficiency.

## OIL-FREE WATER-INJECTED SCREW COMPRESSORS

AQ 15-55 VSD/AQ 30-55 (15-55 kW / 20-75 hp)



Figure 5: OIL FREE WATER INJECTED SCREW COMPRESSORS FROM ATLAS COPCO.

### Flow diagram AQ air-cooled pack

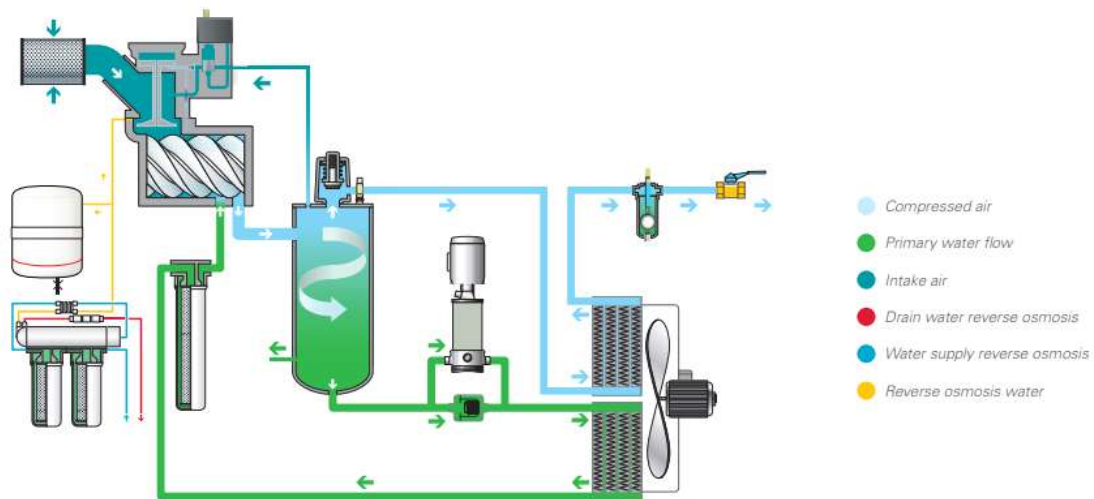

Figure 6 : Flow Diagram of AQ series – Atlas Copco Air Compressors.

The Selected Model in our case would be ATLAS COPCO AQ 37KW- Water Cooled Machine -with a flow capacity of 106 l/s @ 7.25 Bar with a 37 KW Motor.

### Air Reservoir:

Design Pressure: 40 Bars  
Working Pressure: 7 Bars  
Safety Valve Pressure Setpoint: 10 Bars  
No. Of Safety Valves: 2 Nos  
Testing Pressure: 50 Bar.  
Pressure Gauge Range: 0 Bars to 70 Bars.



Figure 7: Air Reservoir: ATLAS COPCO

Volume: 1 cubic Meters @ 7 Bar -High  
Pressure capacity up to 50 bar

**AIR Driers:** We Have Selected ATLAS COCPCO Cerades™ which makes compressed air drying more efficient, cleaner and less costly. As a solid desiccant, it eliminates the downsides inherent to the tiny beads in conventional dryers: Inefficiency,

decay, installation limitations, and environmental and health hazards. The Technical Specifications are as follows: Pressure dew point °C-20 to -70 Inlet capacity FAD 7 bar(e) 25 to 330 l/s Pressure drop excluding filters 0.04 to 0.3.



Figure 8: Atlas Copco Cerades

Pressure Dew point range: -70 to -20 deg  
C

Flow Capacity @ 7 Bars : 25 l/s to 330 l/s

Pressure drop: 0.04 to 0.3

**Air Filters:**

- **Dust Filtration:** Since We will be using Desiccant solid media and its susceptible to breakdown over long exposure to stale compressed

air we will required dust filtration. We Shall be using Atlas COPCO **DDp+/PDp+** Dust Filtration range of filters.



Image 9: Atlas Copco DDp+/PDp+ Filters

Image 9: Atlas Copco DDp+/PDp+ Dust Filters	DDp+	PDp+
Contaminant	Dry dust	
Filtration technology	Pleated	
Test method	ISO 8573-4:2001, ISO 12500-3:2009	
Particle removal efficiency (% at MPPS)	99.92	99.98
ISO class 8573-1	[2:-:3]	[1:-:2]
Average dry pressure drop (mbar)	49	56
Element service	After 8,000 operating hours or 1 year or 350 mbar pressure drop  For flanged filters: after 4,000 operating hours or 1 year or 350 mbar pressure drop	

Table 2: Performance of DDp+/PDp+ filters

- **Aerosol and water Filtration:** For the Model of this system, we will be selecting UD+ series combines two filtration steps (DD+ and PD+) into a single unique technology that allows you to meet the high-quality requirements of various applications while providing ultimate energy

savings. However, they do not just save you money, but also space by eliminating the need for a second filter. At the same time, these two-in-one filters protect your equipment and processes by efficiently reducing oil aerosol, wet dust and water droplets in your compressed air strea





Image 10 : Atlas Copco DD+/PD+/UD+ filters for Removal of Aerosols and other condensing fluids – Image is directly taken from Atlas Copco Brochures

	DD+	PD+	UD+
Contaminant	Oil aerosol/wet dust		
Filtration technology	Wrapped		
Test method	ISO 8573-2:2018, ISO 12500-1:2007		
Maximum oil carry-over (mg/m <sup>3</sup> )*	0.08*	0.008*	0.001
ISO class 8573-1	[2:-:3]	[1:-:2]	[1:-:2]
Average wet pressure drop (mbar)	119	132	220
Element service	After 8,000 operating hours or 1 year For flanged filters: after 4,000 operating hours or 1 year or 350 mbar pressure drop		
Precede with	Water separation	Water separation & DD+	Water separation

Table 3 : Atlas Copco DD+, PD+ , UD+ Filtration systems.

• Activated Carbon Filters: We Will have to remove any vapour of oil or oil vapours in the system hence we would need ATLAS COPCO QD(+) filters which efficiently reduce hydrocarbons in compressed air, removes odours and oil vapor in your compressed air stream to

protect your investment, equipment and processes. The activated carbon layers will, by the use of adsorption, reduce the residual oil content to less than 0.003 mg/m<sup>3</sup>. The pressure drop is low and stays minimal during the lifetime of the filter.



Image 11: Atlas Copco Activated Carbon Filters QD+ Range for Removal of Oil fumes upto 3 microns in size.

We shall Select the same according to the requirement in the system Design with an Approximate flow rate of 120 l/s@ 7 Bar Compressed air Pressure

**Nitrogen Generators:** We will Physically need to Separate out oxygen and Nitrogen from the compressed air and we shall need a Nitrogen Filter for the same. The Process flow will look as something below:

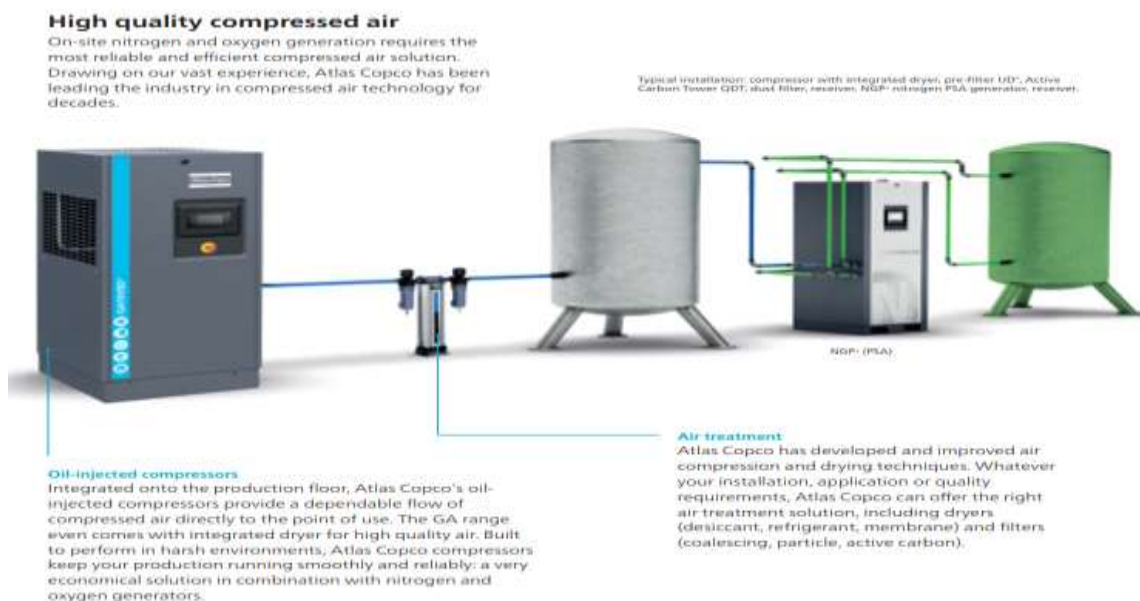

Image 12: Atlas Copco NGP (PSA) General Process Layout

Atlas Copco Nitrogen Generation Systems:



Image 13: Atlas Copco Nitrogen Generators.

The Selected Model is NGM 5 with a flow rate of 82 l/s of Nitrogen generated at 7 Bar at 99.99% purity.

The Generated Nitrogen will be stored in Nitrogen Storage Tank and thereafter sent for liquification while the oxygen generated will be sent for oxygen

liquification and storage. The remaining gases and vapour will be vented out

Liquid Nitrogen Generators Available in the Market As follows: Ref: Kelvin Technology

## Liquid Nitrogen Generators

Cryo Industries offers complete Liquid Nitrogen Generator Systems with two different liquefaction capacities:

- Cryocool-LN10: 10 litres/day
- Cryocool-LN50: 50 litres/day

Two styles are available:

- Direct Feed Design
- Dewar Mounted Design

CRYO's liquid nitrogen generator systems eliminate the cost of buying liquid nitrogen and the hassle of waiting for deliveries.



Cryocool-LN10 Direct Feed Design



Cryocool-LN50 Dewar Mounted Design

Image 14: Liquid Nitrogen Generators: [Liquid Nitrogen Generators \(kelvintechology.com\)](http://www.kelvintechology.com)

**Nitrogen Storage Tanks:** The compressed Nitrogen Shall be stored at Room Temperature In SS Insulated Tanks which the liquid Nitrogen Will be sent to the Cryogenic storage Tanks.



Image 15: Cryo- Containers of Liquid Nitrogen Storage and Liquid Oxygen Storage.

**Cryo-Pumps:** We will need to reliquefy Nitrogen to keep the complete system in Balance Cryocoolers will be used for this process in the complete system. A typical Cut Section of Cryo- Pump is as Below:

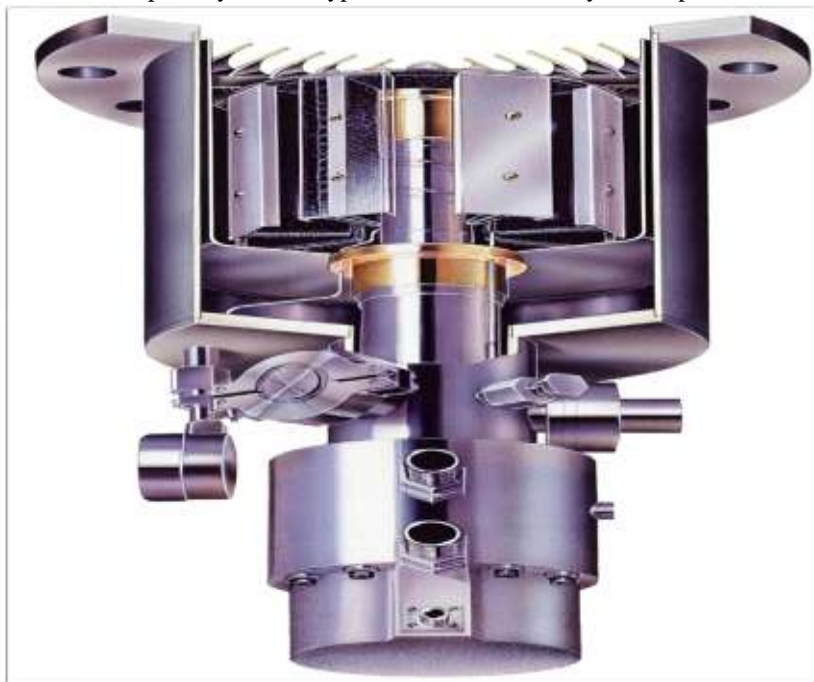

Image 16 : Cryo-Pump Cut Section Ref: Internet

**Liquid Nitrogen Circulating Pumps:**



Image 17: Cryomec LLC Liquid Nitrogen Transfer Pump Submerged Type.

**Nitrogen to Water Heat Exchangers/Nitrogen Boilers/Nitrogen Vaporisers:**



Image 18: Kelvion Process Customisable Heat Exchangers for Cryogenic -Sustainable Solutions for special Applications



In this Case We will be using Shell and Tube Type Heat Exchanger with double safety. The pressure withstanding of such custom designed systems can withstand pressure up to 320 Bar in a temperature range of -200 degree Celsius to 50 deg C. MOC Includes Titanium , Carbon Steel , Non Ferrous Metals Such As CuNi, Haste Alloy , Super Duplex etc.

**Water:** We will be using distilled water with Anti-Freeze additives to vaporise nitrogen and Generate Electricity from low temperature heat sources the cold water thus generated can be circulated across the systems to carry out waste heat , process cooling or for district cooling applications.

<b>Boiling temperature (at 101.325 kPa):</b>	99.974 °C = 211.953 °F
<b>Bulk modulus elasticity:</b>	2.15 x 10 <sup>9</sup> Pa or N/m <sup>2</sup>
<b>Critical temperature:</b>	373.946 °C = 705.103 °F
<b>Critical pressure:</b>	217.7 atm = 220.6 bar = 22.06 MPa (MN/m <sup>2</sup> ) = 3200 psi (=lbf/in <sup>2</sup> )
<b>Critical density:</b>	0.322 g/cm <sup>3</sup> = 0.62478 slug/ft <sup>3</sup> = 20.1018 lbm/ft <sup>3</sup>
<b>Ionization constant, pK<sub>w</sub> (at 25°C):</b>	13.995
<b>Latent heat of melting:</b>	334 kJ/kg = 144 Btu(IT)/lb
<b>Latent heat of evaporation(at 100°C):</b>	40.657 kJ/mol = 2256 kJ/kg = 970 Btu(IT)/lb
<b>Maximum density (at 4 oC):</b>	999.975 kg/m <sup>3</sup> = 1.9403 slug/ft <sup>3</sup> = 8.34519 lbm/gal(US)
<b>Melting temperature (at 101.325 kPa):</b>	0 °C = 32°F
<b>Molar mass:</b>	18.01527 g/mol
<b>pH (at 25°C):</b>	6.9976
<b>Specific heat (C<sub>p</sub>) water (at 15°C/60°F):</b>	4.187 kJ/kgK = 1.001 Btu(IT)/(lbm °F) or kcal/(kg K)
<b>Specific heat ice:</b>	2.108 kJ/kgK = 0.5035 Btu(IT)/(lbm °F) or kcal/(kg K)
<b>Specific heat water vapor:</b>	1.996 kJ/kgK =0.4767 Btu(IT)/(lbm °F) or kcal/(kg K)
<b>Specific Weight (at 4 oC):</b>	9.806 kN/m <sup>3</sup> = 62.43 lbf/ft <sup>3</sup>
<b>Thermal expansion from 4 oC to 100 oC:</b>	4.2x10 <sup>-2</sup> (Note! - volumetric temperature expansion of water is not linear with temperature)
<b>Triple point pressure:</b>	0.00604 atm = 0.00612 bar = 611.657 Pa = 0.08871 psi (=lbf/in <sup>2</sup> )
<b>Triple point temperature:</b>	0.01 °C = 32.02 °F

Water is freely Available Nature and we shall be using industrial process waster heat to generate distilled water by vacuum distillation process as shown below:



Image18: Vacuum Distillation System – Fresh Water Generator from GEA: Ref: [SeaWaterDistiller \(gea.com\)](http://SeaWaterDistiller.gea.com)

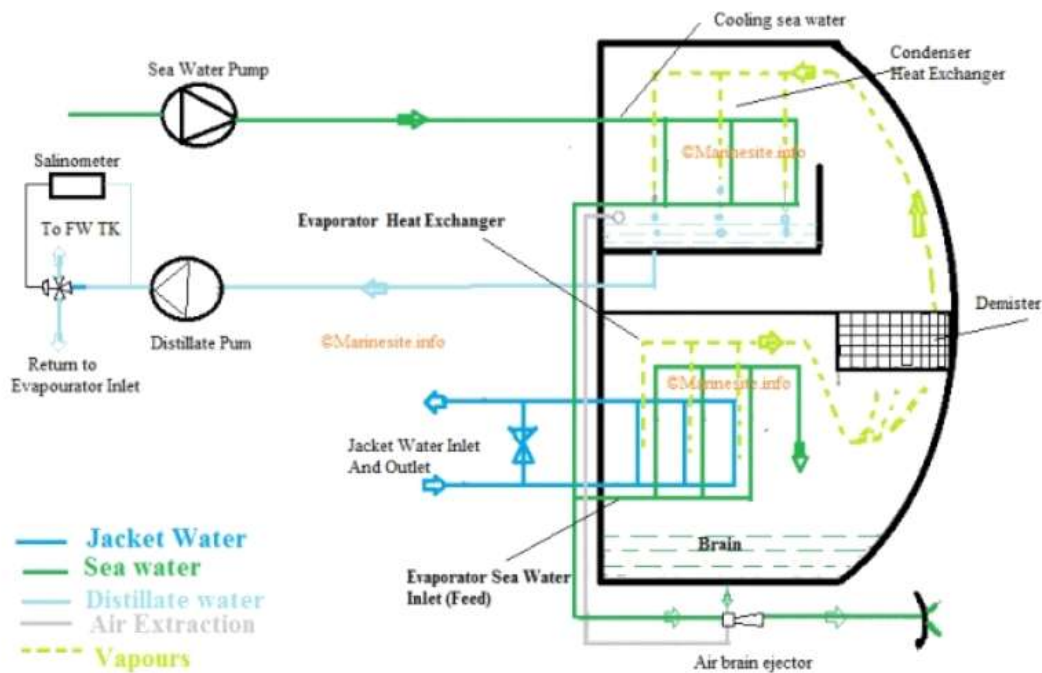

Image 19: Plate Type Fresh Water Generator – Vacuum Distillation of Industrial Waste Water Applications or Fresh Water Generation from Sea Water. Ref: [Marinesite.info](http://Marinesite.info)



Image20: Anti-Freeze

An Anti-Freeze is an additive which lowers the freezing point of water or a given solvent. It Helps in protecting the line from freezing so which would otherwise hinder the flow of water across the circuits and will reduce the efficiency of heat transfer across the tubes of the Heat exchangers.

**Water Circulating and Transfer Pumps:** Considering the properties of water and with optimum operating efficiency we will be integrating grundfos MAGNA 3 Series Pumps For Hot Water Cicalation in the Nitrogen Boilers/Vapourisers.the flow rate shall be optised with the VFD mounted on the pump motor by varing the speed of the pump.



Image 21: GRUNDFOS MAGNA 3 Hot Water Circulation Pumps.

**Water Transfer and Booster Pumps:** We will Be using Grundfos CR – Flex and CRE Pumps Which Can run Both On AC or DC Supply based on the Demand of the Project. The Pumps Shall be Circulating water from Solar Heating's Systems , Geothermal Heats , Air to Water Heaters etc. With

The Permanent Magnet and IE-5 Class of Motor Efficiency we will get best possible output with this systems , In the Future we can use Nitrogen to cool the motors and even recover the waste heat from the motors.



Image 22: GRUNDFOS CR-Flex Hot Water Circulation Pumps

**Thermal Power Storage (Molten Salts):** Now Since we have access to harnessing the required from low temperature sources, we will need to store this energy in required form the other way of doing so other than cryogenic storage is to use thermal energy storage where the sensible heat of Molten salt is used to storage thermal energy. Based on the applications and usage this kind of systems allows excess heat energy to be stored and used as required at scales ranging from the individual Apartments to Massive smart cities soon to rise up, Usage examples would be balancing out energy between days and nights, Storing energy across different seasons, (Seasonal Energy Storage), Thermal Uninterrupted power supply and storage Energy systems. Storage media include water or ice-slush tanks, masses of native earth or bedrock accessed with heat exchangers by means

of boreholes, deep aquifers contained between impermeable strata; shallow, lined pits filled with gravel and water and insulated at the top, as well as eutectic solutions and Phase Change Materials. Heat storage, both seasonal and short term, is considered an important means for cheaply balancing high shares of variable renewable electricity production and integration of electricity and heating sectors in energy systems almost or completely fed by renewable energy.

**Heat Storage and Use-** Cooling Nitrogen Will be circulated across the Molten Salt to get vapourised and thus drive the air Motors in turn driving alternator to generate electricity and store it in electrical storage systems. Thermocline molten salt storage can be used to store the waste heat and then we just drive turbines by rapidly vapourised nitrogen.

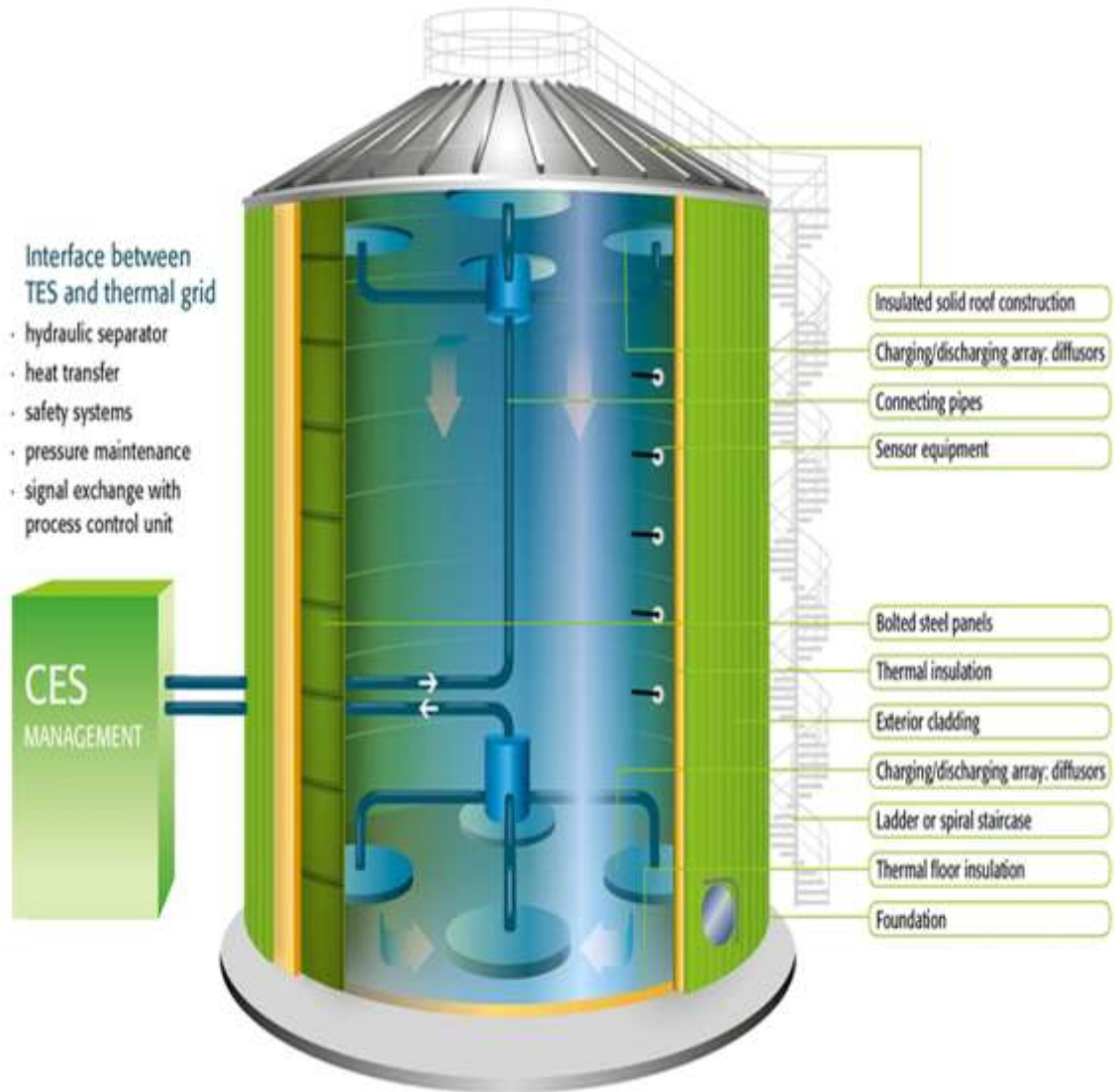

Image23: Thermal Storage Systems : API Energy Thermal Energy Storage Tanks Source: API Website Uk Electrical Energy Generation



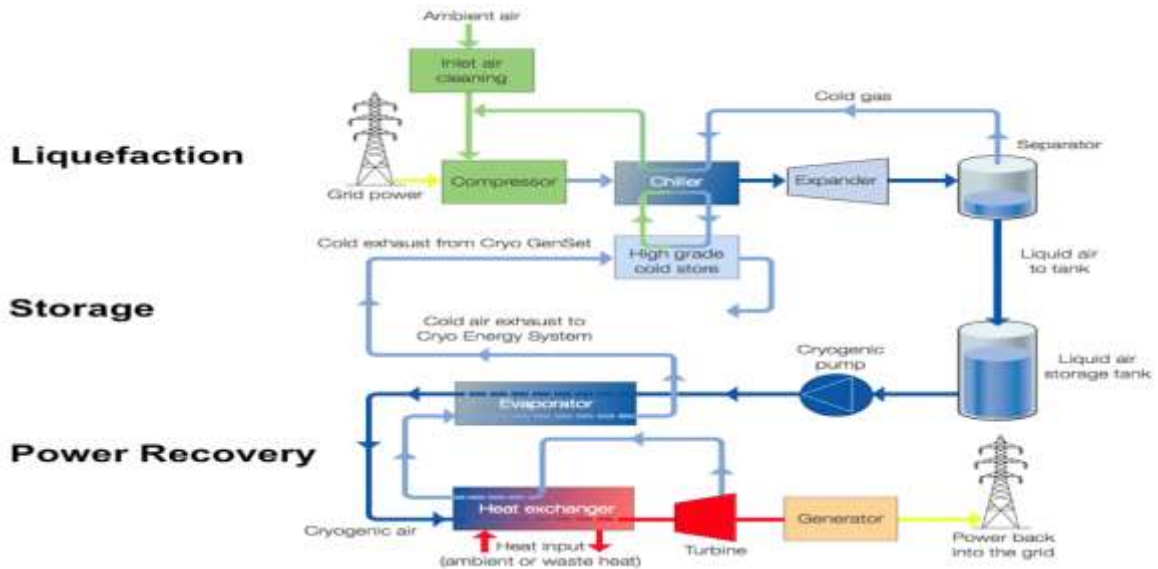

Image 24: Thermal Energy Storage, Utilisation and Electrical Energy Generation System Source: Internet

**Air – Motors:** Air Motors or Compressed air Motors do mechanical work by expanding the air the same this can be done for Nitrogen Gas and we can use them to either run alternators, work as spindle motors or as prime movers for other industrial applications. The Expanded gas is collected with the help of vacuum eductor which is connected at the discharge of the liquid nitrogen pump. The System is automated to open the required number of solenoids based on the power

requirement. The motors have their own speed regulation governor system which regulated the flow along the inlet. The Motors can also be fused with electronic speed regulation system to maintain constant electrical frequency in the circuits by regulating the flow in the inlet. The system is scalable and higher power turbo alternators can be used to generate electricity and store the same in electrical for on mass scale.

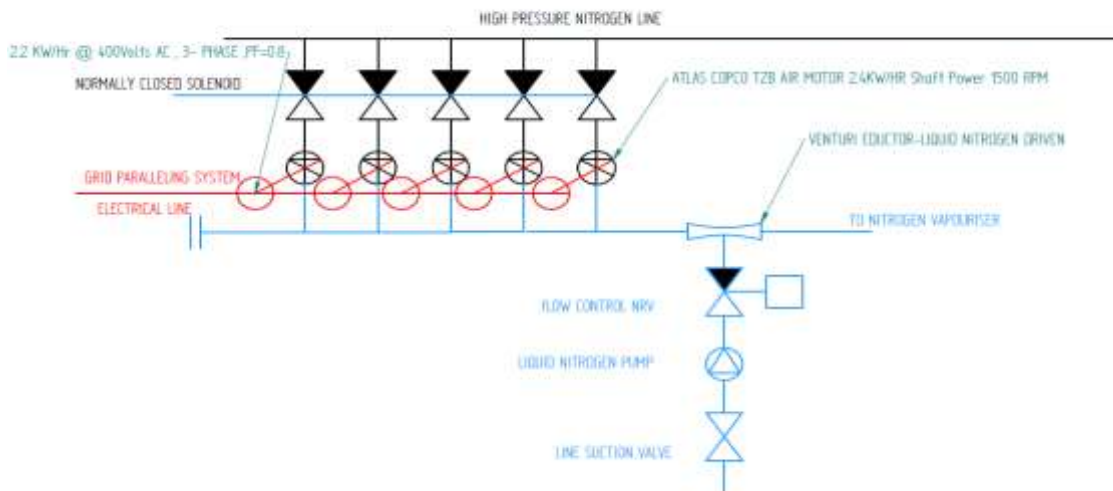

Image 25: Electrical Power generation using Simple air Motors to be driven by Nitrogen.

### Nitrogen Expansion Turbines



Image 26: Simple – Single Stage Air Motor Turbine

The Nitrogen Expansion turbine will use the kinetic energy of the Nitrogen Molecules to convert it into Mechanical power to drive the alternators of Air Compressors. This Energy will then be stored in Lithium Ion Battery Cells for Further usage and power Optimisation.

**Alternators:** This Devices Convert the Rotary Motion into electricity which is the most viable and manageable form of energy. Based on the requirement we will select the alternators from Major Brands Like Stamford or Crompton. A typical Permanent Magnet Alternator Section is As Shown Below:

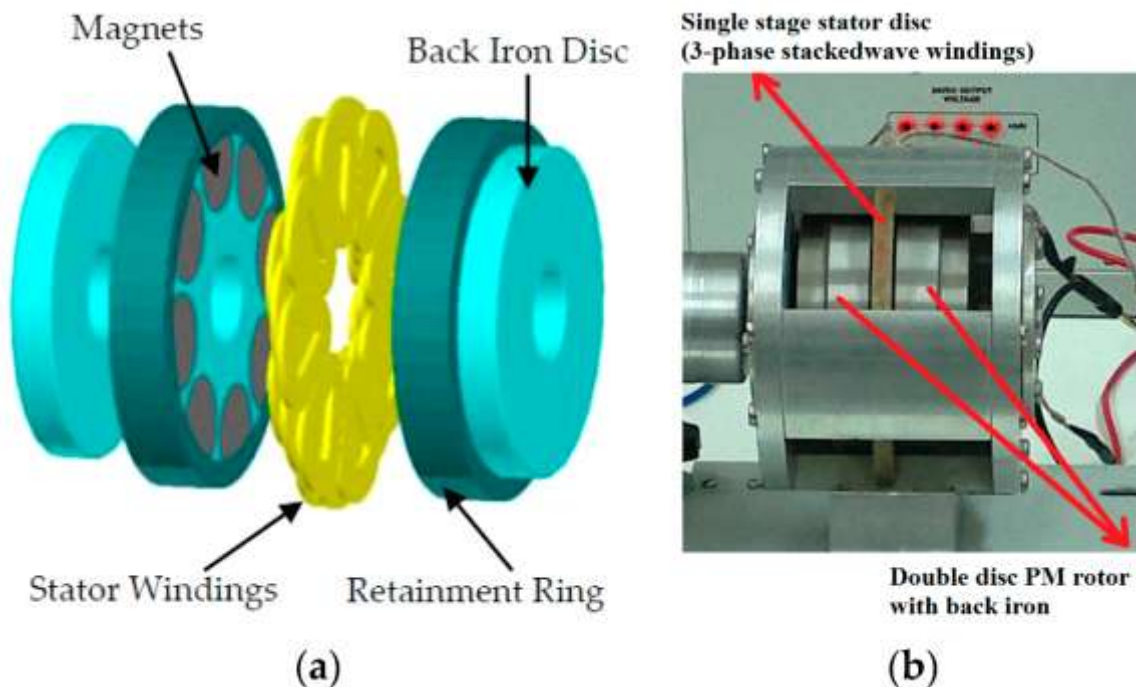

Image 27: Simple Alternator Parts

**Turbo-Alternators:** When a Turbine is Fused with the alternator with Its Required Bearings, Gas Leakage Rotary Seals on a single shaft we call it turbo-alternators. They Convert the kinetic energy of the Nitrogen Gas Directly to electricity by expansion of high-pressure gas.



Image 28: Turbo-Generator Alternator Cut Section

**Turbo-Expanders:** Turbo Expanders Are Mechanical Devices Which Uses the potential Energy of High-pressure gas by expanding it and the energy is thus utilised to drive generator or a compressor. Our Turbo – Expander Will be helping

us to recompress and re liquify Nitrogen When the electrical consumption is low in the expansion tank instead of using multiple conversions or when cryo-coolers are not available.



Image 29: Turbo- Expander – Image Ref: Go Mechanic.com

**Active Magnetic Bearings for Large Alternators:** Active Magnetic Bearings work on the principle of either electro-magnetic levitation and suspension or on super conductor Levitation

system. I one case its about supercooling the conductor on the other hand its about using electrical coils to generate magnetic field to balance and hold the shaft in air. This Bearings are

used inline with back-up bearings and supercapacitors in the circuit to avoid falling of the shaft in case of power cut out. Since the shaft is suspended and is levitating in air it doesn't require

oil lubrication and the friction losses are minimised thus allowing us to achieve higher rpms and efficiency.

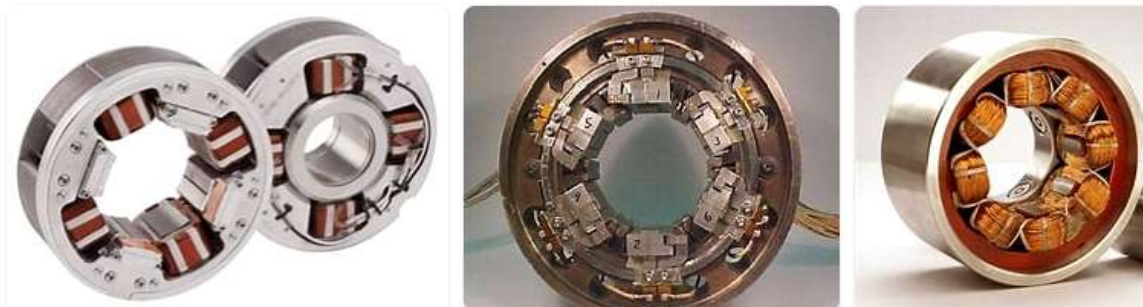

Image 30: Active Magnetic Bearings Source: Internet.

**Piping, Insulations and Energy Transmission:**

Electrical Energy Will Be Transferred via using Sandwiched Busducts or electrical Cables across the electrical Energy Network. While Most of the Circuits will be insulated either with Rock-wool, Mineral Glass Wool , Nitrile Insulation or

High Expanding Foam Based on the intensity of Insulation required and accordingly the thickness of the insulation to optimise energy wastages while the Gases are being transmitted through pipelines shown Below:



Sr. NO	Usage	MOC	Supplier	Pictures
1	Compressed Air / Pressured Nitrogen	Aluminium/SS 316L	ATLAS COPCO-AIR NET	
2	Distilled Water-Hot & Cold	SS-316L - Nitrile Insulated	AQUA-PIPE	

Table 3 : Pipes and SS lines

**Applications of Nitrogen Based Energy Recovery Systems:**

- District Cooling Applications.
- Thermal and Multi-Level Energy Recovery from Industrial Waste Process.
- Generation of Electricity from hot air.

- Generation of Electricity from low Temperature heat Sources such as Geothermal or Solar Radiation Heat- Concentrated Solar Power Cells can be used.
- Cooling of Large Commercial Spaces, Ware-Houses Etc.



- Atmospheric Water Generation.
- Fresh Water Generation on Mass Scale.
- Clean and Green Energy Production for Large Commercial Applications.
- Clean Energy Storage and Management Systems.
- Sustainable Power Generation and Affordable Power Generation and storage systems.
- Pollution free generation of Nitrogen for other applications.
- Safe Utilisation of Potential Energy of Nitrogen in Spaces where transmission of electricity is not possible.
- Spindles of CNC machines and other Systems in the production environment can run on compressed Nitrogen and then can be ejected and mixed back with the liquid Nitrogen using Ejectors
- Small Individual Cooling Requirements at different locations in the systems.
- Superconductor Technology.

## II. CONCLUSION:

We Have Seen that the Nitrogen Based System or Nitrogen Engine is Free of Carbon in the systems Except for the Anti-Freezing compounds used. If we use oil free systems, we have seen that the need for lubricants is completely overturned thus further improving the efficiency of the system. Generating energy by Liquifying Nitrogen and then expanding it allows storage and controlled uses of the system. These Carbon Free systems will revolutionise the way we look at energy and also help us to storage energy in different available forms and use it on demand. Smart Metering systems, Active and Passive Harmonic systems and IOT incorporated in the system can help to efficiently run the system with very minimal maintenance and operation.

### Future Scope of Work:

- Development of Total of Total Integrated System with Further incorporation of Digital control of the system.
- Load Managers and Grid Synchronisation Systems should be developed for scaling up the entire system for mass production of energy and for district cooling.
- This Systems will cool the air to a very large extent by consuming the heat from the air and converting it to electrical energy thus would really help in climate change.
- Electrical Energy Thus Generated from these systems can be transferred Electrically so this can also act as remote heat pumps with minimal losses against conventional thermal transfer systems.

- Digitisation of complete Hybrid Thermal Management system and Improving Process efficiency.
- New revenue streams through circular business models:
- Resilience to climate and linear business model risks:
- Access to green finance and lower capital rates:
- Cost and operational efficiency:
- Resource Management and Resource Efficiency.
- Waste Energy Management and sustainable Manufacturing Systems.
- Sustainability and renewable Energy in manufacturing systems.
- Business Models for Sustainable Manufacturing.
- Design By sustainability for Sustainability.

## REFERENCES:

- [1]. <https://www.atlascopco.com/> - Nitrogen Generators, Turbo-Expanders, Air Filtration systems , Nitrogen Storage Tanks , Air Reservoirs , Plant Optimisers Etc.
- [2]. <https://www.grundfos.com/> - Hot Water Circulating Pumps, Chiller Water Circulating Pumps , DC Motors , Centrifugal Pumping Systems Etc.
- [3]. [Heat Exchangers: Cooling & Heating Systems | Kelvion](#)- Heat Exchangers , Nitrogen Vaporisers etc.
- [4]. <https://www.siemens.com/global/en.html> - Active Magnetic Bearings, Alternators and Switchgear systems.
- [5]. <http://cryomec.com/pumps/> - Cryo-Pumps and Liquid Nitrogen Pumping Systems.
- [6]. Gutowski, T. G., Branham, M. S., Dahmus, J. B., Jones, A. J., Thiriez, A. and Sekulic, D. P. (2009), "Thermodynamic analysis of resources used in manufacturing processes", *Environmental Science and Technology*, vol. 43, no. 5, pp. 1584–1590
- [7]. World Commission on Environment and Development (1987), *Our common future*, Oxford University Press, Oxford.
- [8]. Ayres, R. U. (1989), "Industrial Metabolism", in Ausubel, J. H. and Sladovich, H. E. (eds.) *Technology and Environment*, National Academy Press, Washington D.C., pp. 23–49.
- [9]. UPM; UPM issues its second green bond; March 15, 2021;



- [10]. [https://www.upm.com/about-us/for-media/releases/2021/03/upm-issues-itssecond-](https://www.upm.com/about-us/for-media/releases/2021/03/upm-issues-itssecond-green-bond)
- [11]. [green-bond](#).
- [12]. Westkämper, E., Alting, L. and Arndt, G. (2001), "Life cycle management and assessment: Approaches and visions towards sustainable manufacturing", Proceedings of the Institution of Mechanical Engineers, Part B: Journal of Engineering Manufacture, vol. 215, no. 5, pp. 599–626.
- [13]. Van Berkel, R., Willems, E. and Lafleur, M. (1997), "The relationship between cleaner production and [17] industrial ecology", Journal of Industrial Ecology, vol. 1, no. 1, pp. 51–66
- [14]. Business Wire; Morgan Stanley Sustainable Reality Report Reveals U.S. Sustainable Funds Outperformed Traditional Funds by 4.3% in 2020; February 24, 2021;