

Performance Analysis of Line Start Permanent Magnet Synchronous Motor using Finite Element Method

Harsh Dwivedi¹, Dr.Harendra Singh Rawat², Dr. Rajiv Singh³,
Dr. Shobhit Gupta⁴, Sanyogita Rani⁵

¹ M.Tech Scholar, Department of Electrical Engineering , College of Technology, GBPUAT,Pantnagar (263145), India

^{2,3,4} Associate Professor, Department of Electrical Engineering , College of Technology, GBPUAT,Pantnagar (263145), India

⁵ M.Tech Scholar, Department of Electrical Engineering , College of Technology, GBPUAT,Pantnagar (263145), India

Date of Submission: 12-03-2023

Date of Acceptance: 22-03-2023

ABSTRACT

In this paper, the performance of Permanent Magnet Synchronous Motor (PMSM) is analysed using Finite Element Method. The electromagnetic model of a buried magnet type Line Start PMSM motor is established using the RMxprt module developed by Maxwell, and a two-dimensional model is generated to conduct an electromagnetic simulation analysis. A 3-phase Sinusoidal Pulse Width Modulated (SPWM) Inverter is simulated in Ansys Simplorer Software and Dynamic Analysis of above simulated motor is examined. Performance analysis of PMSM's speed for sudden load changes is observed.

institutions have been making progress to establish a clean, efficient, and environmentally sustainable urban transportation system that uses electric vehicles (EVs). Therefore, research on high-performance drive motors for EVs has been a top focus for a while. A competitive alternative to the conventional AC motor for EVs is the PMSM, a rotating synchronous machine with permanent magnets on the rotor and a stator with three-phase sinusoidal distributed windings. Their main advantages such as high efficiency, which is due to the use of permanent magnets for excitation that consume no power, and high-power density which can produce high flux densities and high torque. [2].

I. INTRODUCTION

The Sixth Assessment Report from the IPCC assessing scientific, technical, and socio-economic information regarding climate change suggested that "Meeting climate mitigation goals would require transformative changes in the transport sector". Further on, it also reported that in 2019, direct Green House Gas emissions from the transport sector accounted for 23% of global energy-related CO₂ emissions out of which 70% of direct transport emissions came from road vehicles.[1].

Due to the fact that CO₂ emissions and air pollution have become a global problem, alongside economic issues, governments and academical

II. ESTABLISHMENT OF FINITE ELEMENT METHOD OF PMSM MOTOR

The motor stator diameter, iron core length, groove shape, permanent magnet size, and other part sizes are entered into the Maxwell RMxprt module to create a model of the motor. Next, material attributes are added to create a Maxwell 2D model, which is then used to set the motor's moving parts, boundary conditions, and splitting. Table-1 displays the fundamental structural characteristics of a permanent magnet synchronous motor.

Table-1: PMSM parameters

Parameter	Specification	Parameter	Specification
No. of stator poles	4	No of rotor poles	4
No. of stator slots	24	Outer diameter of rotor	74mm

Outer diameter of stator	120mm	Inner diameter of rotor	26mm
Inner diameter of stator	75mm	Length of shaft	65mm
Stacking factor	0.95	Fractional loss	10W
Winding layers	5	Windage loss	10W
Conductors per slot	52		

Set the excitation source, specify the boundary condition, and create a network partition of the motor's components in order to get an accurate electromagnetic analysis result for the motor. Figure 2 depicts the Maxwell motor body two-dimensional model and its network dissection, demonstrating how well the motor model was established and how it met the system's requirements.

RMXprt view of the 4-pole, 24 stator slot geometry of line start PMSM is shown in the

Figure 1. The stator geometry is type-2 slotted and is laminated. It is made of SMC steel alloy. Because the majority of eddy current losses occur in the stator core, a laminated core is used to reduce these losses. Stator is built with 24 slots. The number of slots is determined by the pole slot combination ratio for optimal performance. The three-phase winding is installed in the stator slots, producing a synchronously revolving field when energised.

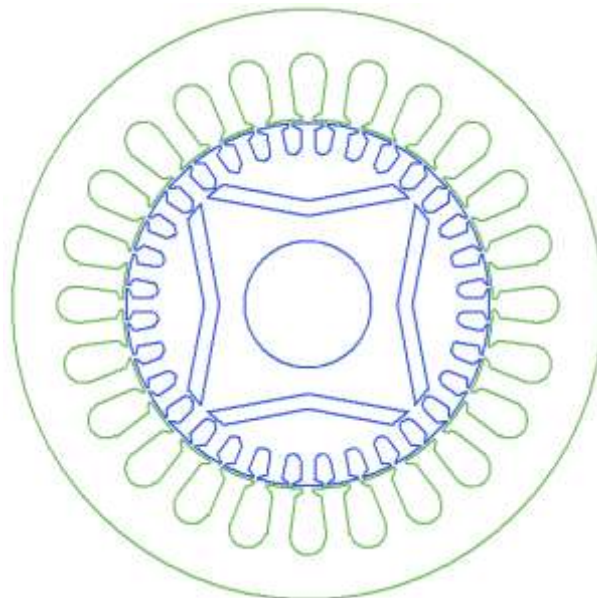

Figure-1 RMXprt view of PMSM

Finite element method involve subdividing a large single domain into a large number of small elements known as finite elements. A set of simple algebraic equations governs each finite element. The solution is approximated by using variational methods to minimise an error function associated with the solution. Maxwell has the functionality of

automatically generating meshes from the domain region's geometry outlines. This reduces meshing computation time and manpower costs. Due to the symmetry of the geometry, the one-fourth section of the stator and rotor assembly discretization is shown in Figures-2.

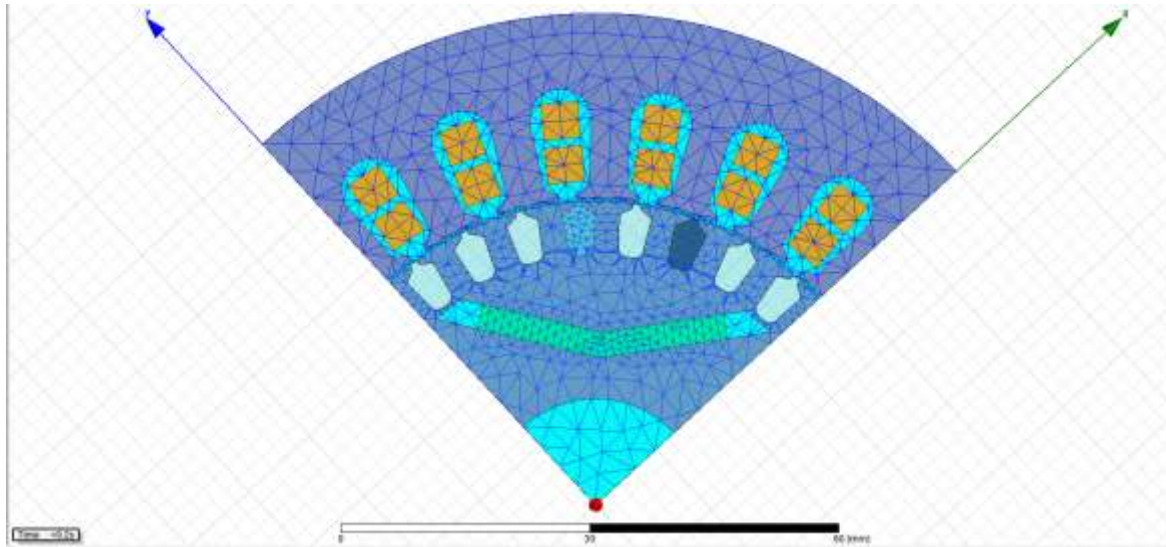

Figure-2 Discretization of PMSM

The 2D model of motor body Maxwell is shown in Figure-3 and Figure-4, which shows that the establishment of the motor model are ideal and confirms to the system requirements.

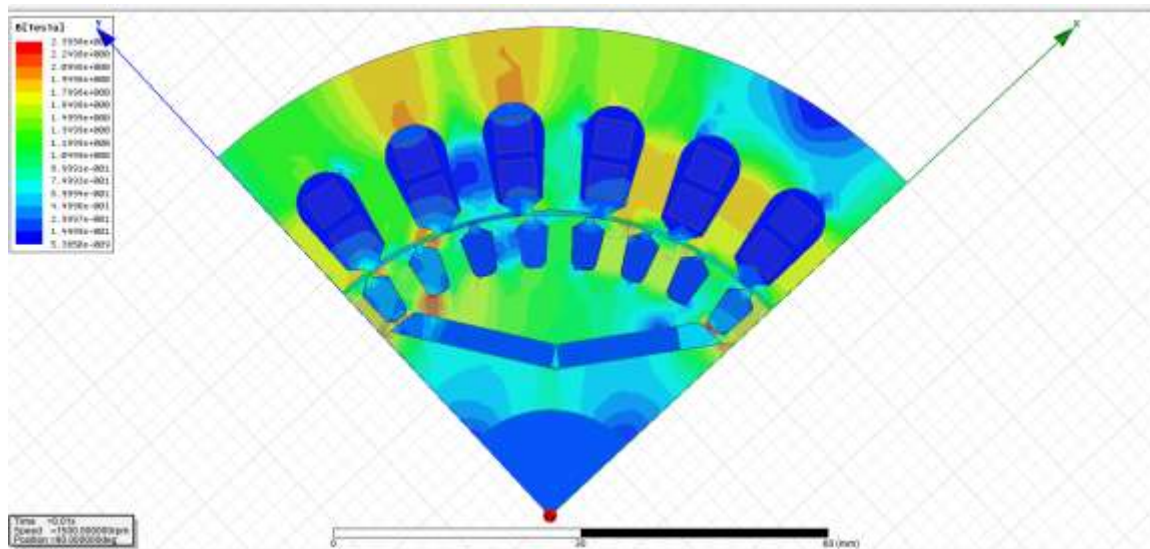

Figure-3 Magnetic Flux density magnitude

The variation of magnetic flux density vector is shown in Figure-4. As we can clearly observe one pole formation in one fourth of machine, so, therefore we verify that it is a four-pole machine as we have one pole in each quarter.

III.SIMPLORER MODELING OF CONTROL SYSTEM

A three phase SPWM inverter is designed in Simplorer software as we need a controlled source for dynamic analysis of our simulated PMSM motor. Main circuit module is shown in Figure-5, the inverter mainly consists of 6 IGBT and 6 diodes, the power supply is the DC voltage source. Through SPWM control module to generate the control signal and drive the conduction and turn-off of IGBT. [7].

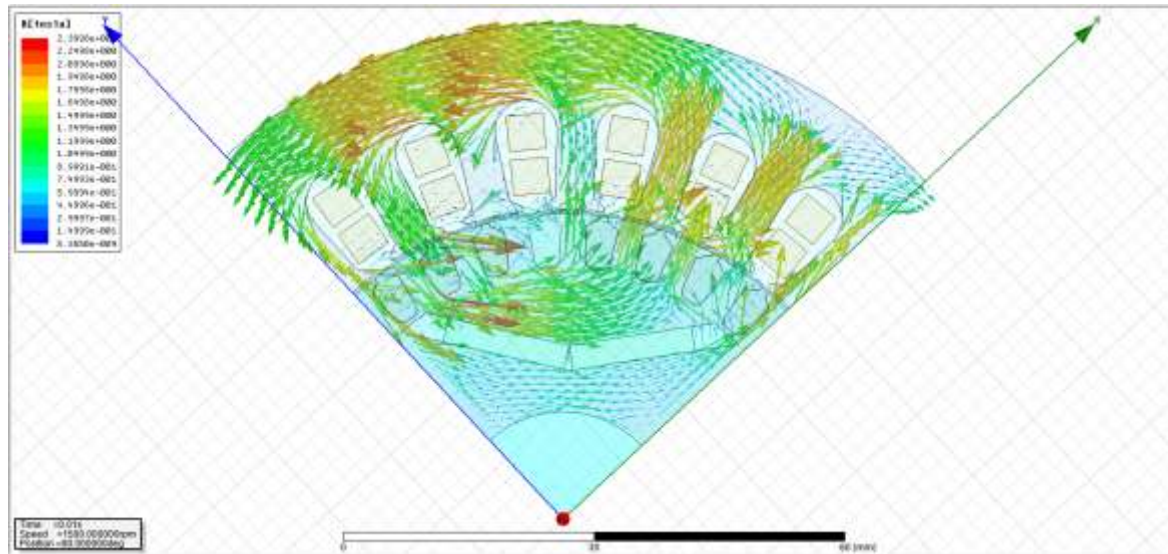

Figure-4 Magnetic Flux Density vector

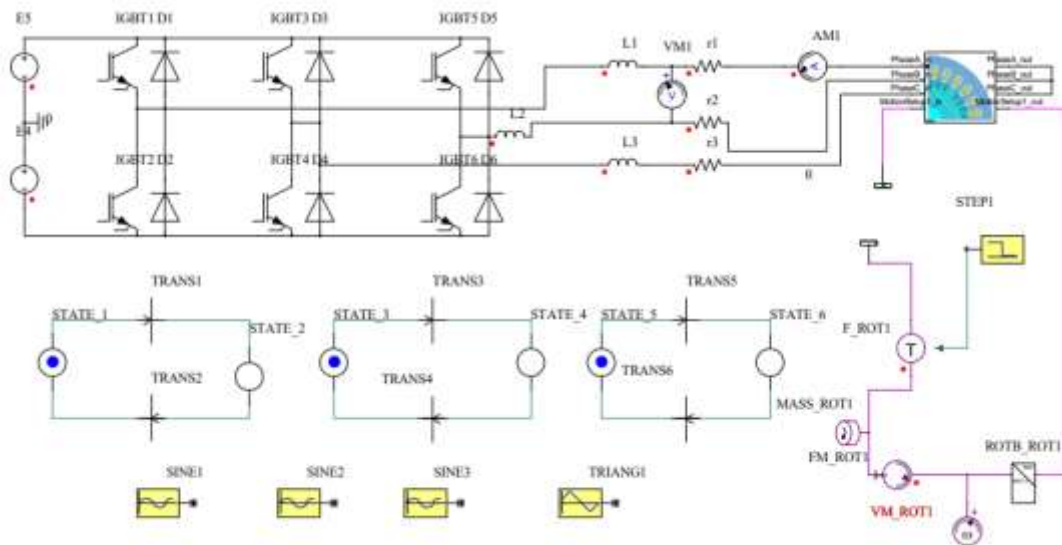
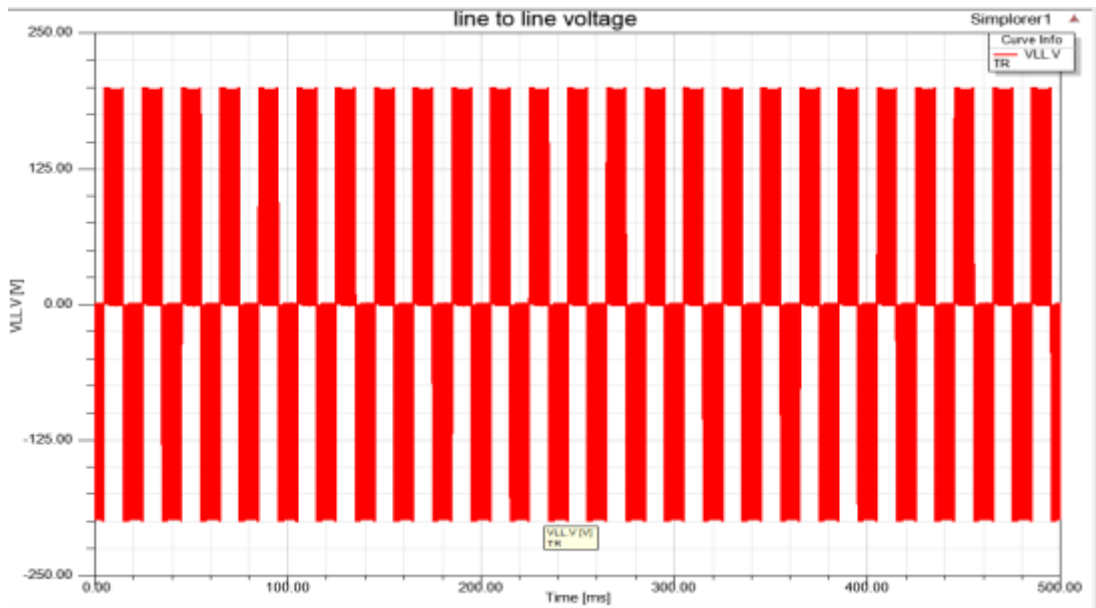

Figure-5 3-phase SPWM inverter with PMSM

Figure 5 can be analysed in three parts for simplification. The first part is VSI whose current and voltage, for a balanced 3-phase load, is shown in Figure-6 (a) & (b). The other two parts are PMSM and its load. Hence using this system we can vary load for any assigned voltage and we can analyse dynamic behaviour of our designed PMSM.

Sinusoidal Pulse Width Modulation

SPWM modulation is based on constant amplitude pulses with different duty cycles for each period. The width of pulses is obtained by modulation of a carrier to obtain the desired output voltage and to reduce its harmonic content. The carrier signal of SPWM is usually a triangular wave with a high frequency, generally in several KHz. The modulation signal of SPWM is a sinusoidal waveform with a frequency equal to the desired output voltage frequency (50 Hz). [3].



(a) Output voltage (for balanced 3-phase load) of SPWM Inverter

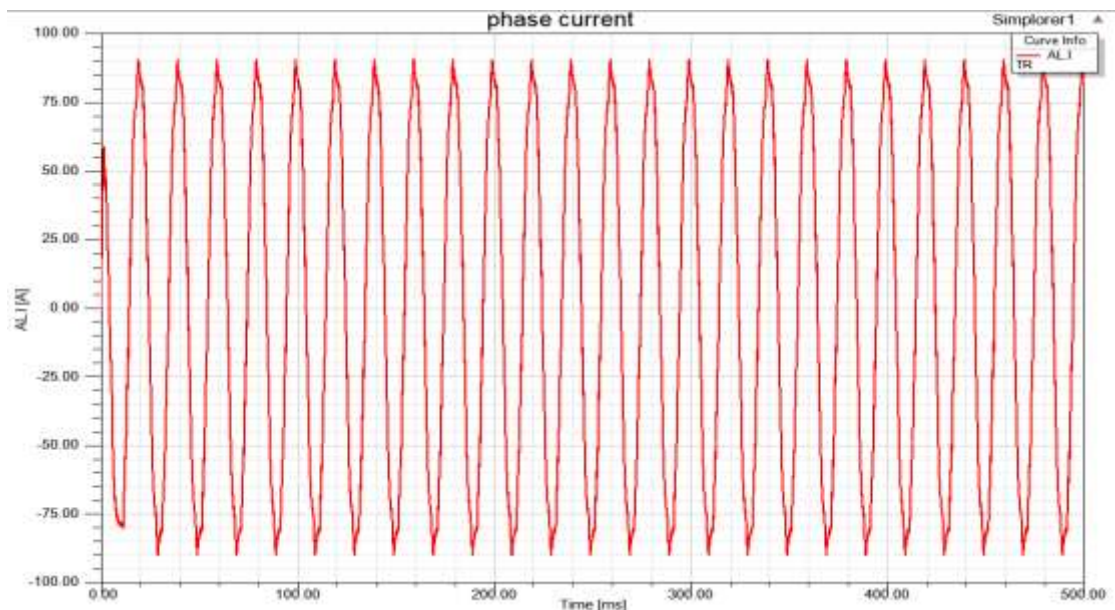

Figure-6 (b) Current (for balanced 3-phase load) of SPWM Inverter

In Figure 5, simulated model of PMSM is connected to external source and its performance is evaluated. A step signal is connected at load side which is bound to get activated at 0.75 sec, and

hence by the application of sudden load torque, speed is observed as shown in Figure 7.

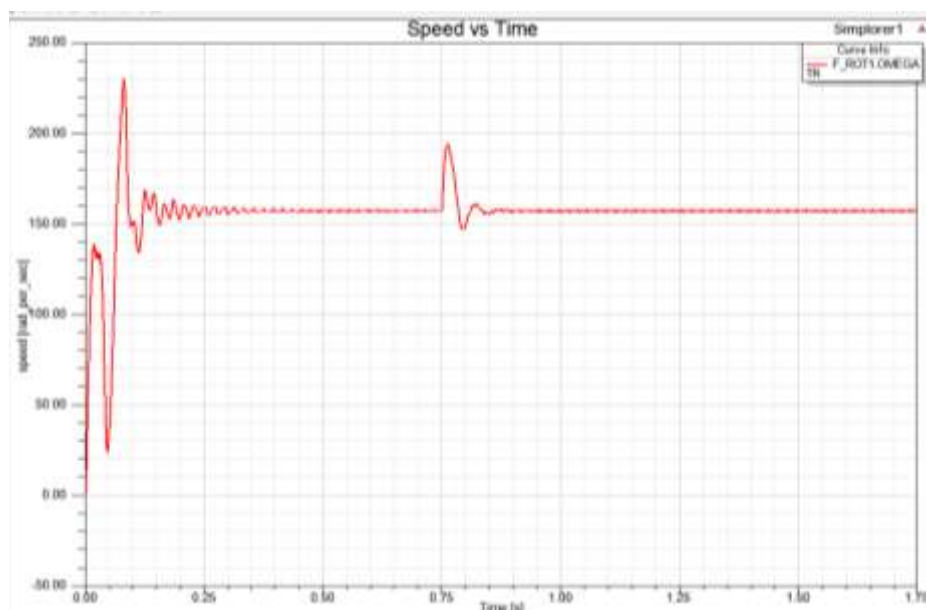

Figure-7 Speed vs Time graph with sudden loading at $t=0.75$ sec

V. CONCLUSION

The performance of Permanent Magnet Synchronous Motor (PMSM) is analysed in this paper using Finite Element Method. A buried magnet type Line Start PMSM motor is simulated using Ansys Maxwell Software. Finite Element Method for the transient analysis of simulated PMSM in Ansys Maxwell software gave us better understanding of flux pattern and magnetic field. A 3-phase Sinusoidal Pulse Width Modulated (SPWM) Inverter is simulated in Ansys Simplorer Software and Dynamic Analysis of above simulated motor is examined.

REFERENCES

- [1]. Portner, H. O., Roberts, D. C., Adams, H., Adler, C., Aldunce, P., Ali, E. and Fischlin, A. 2022. Climate change 2022: Impacts, adaptation and vulnerability. IPCC Sixth Assessment Report.
- [2]. Sanguesa, J. A., Torres-Sanz, V., Garrido, P., Martinez, F. J., and Marquez-Barja, J. M. 2021. A review on electric vehicles: Technologies and challenges. *Smart Cities*, 4(1): 372-404.
- [3]. Bhimbra P.S. 2010. *Power Electronics*. Fourth Edition, Khanna Publishers, New Delhi, India. 482 p.
- [4]. Blaschke, F. 1972. The principle of field-orientation as applied to the transvector closed-loop control system for rotating-field machines. *Siemens Reviv.*, 34: 217–220.
- [5]. Fitouri, M., Bensalem, Y., and Abdelkrim, M. N. 2016. Modeling and detection of the short-circuit fault in PMSM using Finite Element Analysis. *IFAC-Pap.*, 49(12): 1418-1423.
- [6]. Mersha, T. K. and Du, C. 2021. Co-Simulation and Modeling of PMSM Based on Ansys Software and Simulink for EVs. *World Electr. Veh. J.*, 13(1): 4-16.
- [7]. Rashid M. H. 2004. *Power electronics: circuits, devices, and applications*. Third Edition, Pearson/Prentice Hall, New Delhi, India. 552 p.
- [8]. Stulrajter, M., Hrabovcova, V., and Franko, M. 2007. Permanent magnets synchronous motor control theory. *J. Electr. Eng.*, 58(2): 79-84.
- [9]. Silvester, P. P. and Ferrari, R. L. 1996. *Finite elements for electrical engineers*. Cambridge university press, London, United Kingdom. 356 p.