

# Smart Home System Under Over Voltage Protection

Al-Furati, Israa S. <sup>\*1</sup>

<sup>1</sup>University of Basrah, Electrical Engineering Department, Basrah, Iraq.  
Corresponding Author: Al-Furati, Israa S.

Date of Submission: 11-03-2024

Date of Acceptance: 21-03-2024

**ABSTRACT:**In this paper, a new supervision system is designed to conserve energy within smart homes, which reduces electrical power consumption, and save the electrical energy. This system consists of two-part: the software control and the hardware design. In the software control; the system is used to control several devices that are operating under the same smart home depending on the priority and the current allowed to construct an overvoltage protection system. On the other hand, the hardware design of the proposed approach consists of a central control unit represented by a microcontroller(AT mega) and connected to a group of sensors(current sensor, relays, conductors, keypad, and LCD screen to display the current used by any loads). The applied scenario for this system is ordered as follows: the sensors in the hardware part are sensed by the whole system and measure the current used in several rooms in the smart home. This information to the primary control device in the software GUI employs controls and feedback information to turn loads according to their orders and amount t of current driven by them. The central control unit is an essential part of the proposed system. It receives the current reading information using hardware sensors and processing it according to the amount of current allowed to each room to protect the smart home's overvoltage system. The control procedure is design to explain the operating principles using a graphical user interface system that is programmed using the VB platform application system. The control procedure is repeated and pragmatic to the AT mega microcontroller to keep the energy drawn of the whole systems. The proposed approach is applied and test using different experimental results to study the performance. The results showed a clear reduction in electrical power consumption, which consequently reduces the cost of electricity delivered to homes in addition to conserving energy. Also, the simulation result shows that this

method can buildings sector signifies the chief energy.

**KEYWORDS:**Current Sensors, Energy Saving, Over Voltage Protection, Smart Home, VB Platform Application System.

## I. INTRODUCTION

At the present time, with the development of information technology, digital communications, and software, there has become an enormous wealth in developments that have appeared in all areas of life, including military, medical, and navigational applications, and in factories [1]. The development has also extended to include inside our homes, including electrical appliances and all means of luxury, until it has extended to the home itself and there are many Attempts to make our homes as smart as possible are now controlling electrical appliances, cameras, and the system of opening and closing doors all electronically and remotely, even the process of cleaning the house, cooking, washing clothes, and everything that leads to digital transformation that facilitates the means of luxury and comfortable living that our parents and grandparents cultivated in the past [2]. With the tremendous development that we talked about, there have become several attempts and practical studies to develop smart home systems, and individuals and engineers have become proud of every achievement and every new idea that adds development in this field, which would promote the product to be sold easily, and among them it was proposed to apply these ideas to the construction of homes in residential complexes. In remote areas where people have been attracted to live based on the imaginative specifications that have been developed and the high security through monitoring their homes and children remotely, and with people's preoccupation with this life, the security system has become, the most important system on which people compete to buy homes [3]. It has been noted that the homes that are

distinguished with these specifications, they are sold easily and at very high prices compared to the prices of ordinary homes that do not have these specifications with the development of countries [4-6], the increase in the number of people, and the development taking place, the demand for energy increases, and the final use of energy is considered an important requirement in the residential sector, and thus the need to control the load in residential buildings within complexes that consume high energy increases, as it is used for unnecessary things, such as the use of energy heating, convectors, and cooling [7]. It is large, even if they do not need to use it, and thus it is considered wasteful, as it draws double current, which causes the load to fall or pay high amounts to electricity consumption bills. In recent years, there have been several attempts to reduce this phenomenon by imposing taxes and collections, which resulted from weak controls imposed by the state, in addition to people's misconceptions about the use of energy and the relationship between traditional methods of consuming electricity and the use of heating and cooling. There is a large group of research papers that were applied on the ground and that were developed as samples and used, and from these studies, development and modifications were made until smart homes were developed. There are several Theories and technologies that are used to saving energy in the smart home such as: in 1999 Atkeson and Kehoe [8], suggest a new technique called "putty clay", that is used a method through which he was able to increase production and reduce demand for energy by adopting a fixed ratio that cannot be modified, which is the ratio of capital to energy. The reason for reducing demand is that capital increases in the long run relative to energy because factories always raise capital and production, which It causes an increase in production while reducing the demand for energy. This method is considered the starting point after which all economic concepts in the production of electrical energy began. In 2002, another idea was proposed by Doms and Dunne [9] Which is based on another principle, which is that the development of technology leads to and contributes greatly to the rise in fuel prices and thus increases the demand for energy, which leads to resorting to manufacturing industries, which provide energy greatly through the use of modern technologies. As the world entered the decade of the 2000s, the field of solar cells was clearly entered and used in the field of improving energy and its quality. It also contributed significantly to eliminating electricity sources, which cost countries huge amounts of money, as the amount of energy is controlled

through several calculations based on the internal and external temperature. As well as the roofs of tall buildings to calculate the amount of energy required and place the solar cell panel based on the angle calculated by these measurements, which contributes significantly to reducing consumption. The field of discovering solar panels is also considered a qualitative leap witnessed by the whole world and is in constant development. Future ideas and plans related to this topic are under study [10]. The LED is considered one of the most important innovations that has greatly helped in reducing energy consumption, as it draws very little current that does not affect the general system, as it saves more than 90 percent of the energy that was previously consumed by ordinary incandescent bulbs, and the heat generated from it is very small, reducing by a factor of five. Twenty times more than before, which reduces the period required for replacement, meaning it needs to be changed once, for example, every four years instead of two or three times a year [11]. Scientific research and studies continued in the field of energy saving for smart homes until they included many technologies such as: Smart home hubs [12], this method is considered very ideal for controlling energy and tracking its use by providing a smart home that enjoys all amenities, as the energy is adjusted at times when the home owners are at work for the purpose of reducing consumption by setting the energy level to a state of automation and optimization through which it is scheduled. Work for both cooling and heating devices, which are often the most energy consuming, and then reset them shortly before returning home. On the other hand, to save a higher amount of energy, the operation of the dishwasher is adjusted so that it can do its work at night, since energy is cheaper at these times than at other times, and it is also possible Programming the TV to turn it off when it is less used, and all these ideas to reduce consumption, save more material, and reduce high costs. With home appliances by automating these devices to save time and money. Other important ways to reduce consumption are connecting Internet applications [13]. For example, we can order coffee from the coffee maker by automating the coffee maker device with the phone so that it is prepared as soon as we wake up. It is also possible for the electric oven to operate at night before returning home to prepare dinner. It is also possible to improve the energy use of the refrigerator and freezer from by reducing temperatures. There are many methods available nowadays, such as: Smart thermostats, LED lights, Smart plugs Energy-efficient insulation, and power strips, Cool roofs,

High-efficiency heat pumps, Smart motion sensors, and Smart HVAC vents [14]. All of these methods are considered a smart way of life that saves energy and is based on providing a smart ecosystem inside homes, in which companies and designers compete to provide this environment to make life more luxurious. The paper is arranged as follow: Section (II), describe the software design of the proposed system, while section (III), explains the hardware construction; the experiment result is offered in section (IV). Finally, conclusions are conferred in (V).

## II. THE HARDWARE DESIGN CONSTRUCTION

Smart home techniques using energy-saving with overvoltage protection receive a lot of attention in the contemporary world of technologies since it saves the whole energy and minimizes the designer's required cost. In order for the design to be successful, it must be supported by a clear implementation. The proposed system consists of two parts: the first is the physical components and the second is the software components. In this field, we will discuss the physical components that were built for the success of this proposed system, as Figure.1 shows the general idea of the structure and the physical components.

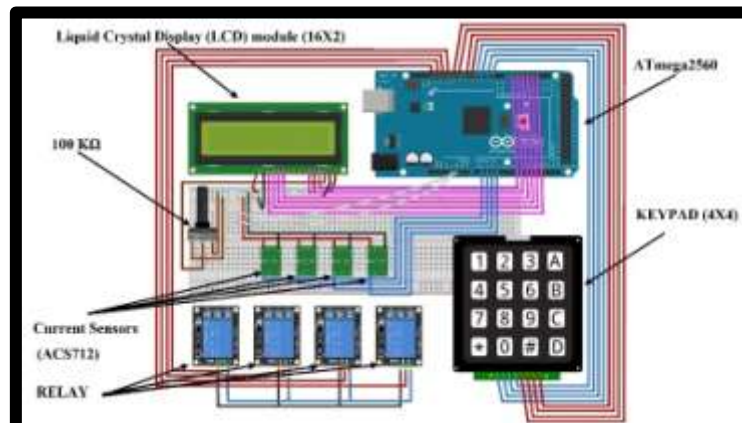

Fig. 1. The Schematic Diagram for the Hardware System.

It is shown that the schematic diagram consists of: four current sensors (ACS712) [16], from the Allegro® that can carry up to (30A) AC or DC current Fully Integrated which are used to sense the current drawn with four loads. The Features and Benefits of using the current sensors (ACS712) is: 1) 80 kHz bandwidth, 2) Low-noise analogue signal path, 3) 5  $\mu$ s output rise time in response to step input current, 4) Nearly zero magnetic hysteresis, 5) 66 to 185 mV/A output sensitivity, 6) Small footprint, low-profile SOIC8 package and Total output error 1.5% at TA = 25°C. The current sensor (ACS712) is obtainable with a small exterior mount 'SOIC8' package. It involves a copper conduction pathway placed adjoining the die's surface with an accurate linear hall circuit. On the other hand, four contactors (An electromagnetic device that is usually used to break an electrical circuit and is activated using a current and voltage difference that is less than what is required in electrical circuits, depending on the nature of use) that is used to control the four loads of operations using four relays [17], (SRD-05VDC-SL-C) to

switch (ON or OFF) with 100 K $\Omega$ . The parameters are entering into the system using the KEYPAD (4X4), and its features are: 1) Connector: Dupont 8 pin, 0.1 inch 2) Cable Length: 85mm, 3) Size 68.9 x 76 x 0.8mm, (2.54mm), and the Weight: 7g, where the maximum allowed current and the operation order to each load are entered using the Keypad [18]. All these components are carefully connected through a microcontroller, ATmega2560 from Mega 2560 Rev3 technique with: 1) 54 digital pins, 2) 16 analogue inputs, and 4 serial ports. Using this type of Microcontroller can connect multi-devices through the (4X hardware) serial ports. The computer is connected to the hardware system through a USB cable connector, and the power supply is starting ON to get started to the battery [19]. For design purposes, the microcontroller is compatible with all other shields in the whole system. In the end, the readings of all the sensors are collected and sent to the central control unit represented by the microcontroller, and thus the results are displayed directly through a small display screen(Liquid-crystal display LCD)

to know the status and then treat the problem and thus save energy and achieve what is required [20], (model 16X2). LCD is a screen displaying crystals arranged in the form of a matrix containing a number of pixels, which is defined as a group of points within one square centimetre, where the

crystal converts light into an image or symbol by reflecting the light on the crystal from the back. The whole system construction is shown in Figure.2. and Figure. 3 show the front- view of the hardware construction.

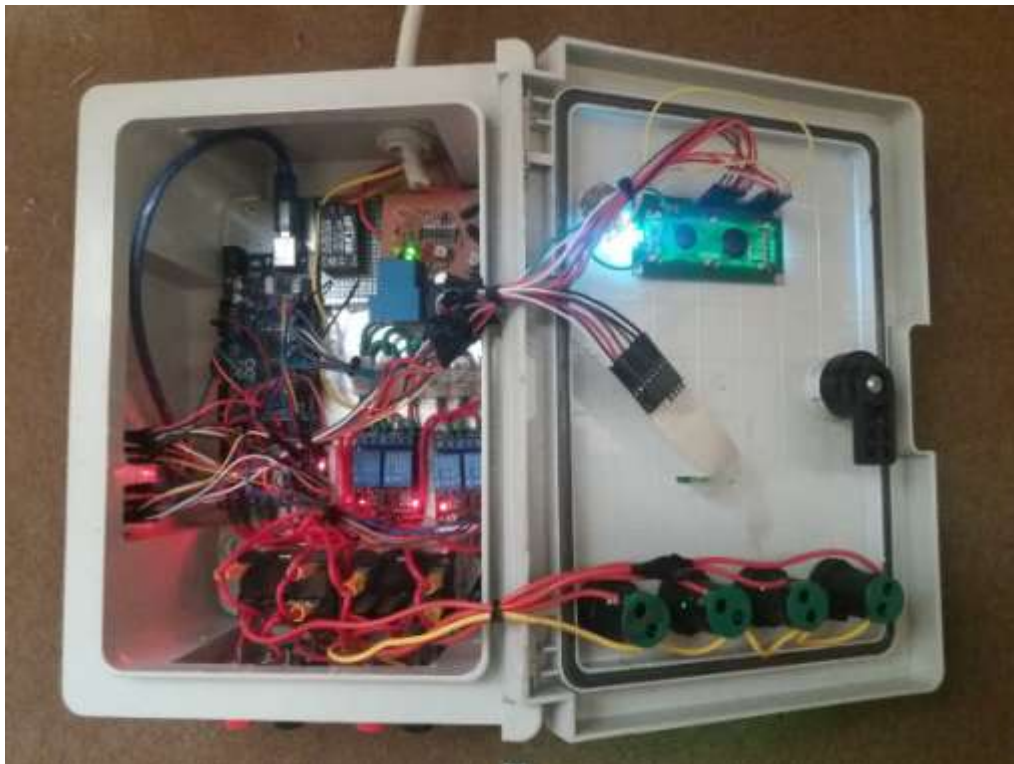

**Fig. 2: The Hardware Construction System (Prototype).**



**Fig. 3: The Front-View of the Hardware Construction.**



### III. THE SOFTWARE DESIGN CONSTRUCTION

As we explained previously in the design section, implementation will not be successful without programming the tools on the ground, observing the results, and studying whether they are correct or incorrect. In this section, we will discuss programming the system and using Visual Basic. In this section, the system protection software is described in details, where a visual basic program is used to simulate the overvoltage protection system in a smart home. In this control system, the current of multi-devices in the intelligent home is chosen randomly using ten

different fields. The control simulation assumes that two levels are used discussed, the high current load (such as the air condition) and low current load (such as lights). The complete control of the proposed system is applied according to the priority and the current level load. The importance is chosen using ten fields to recognize the order of operations, and this scenario is done by simulating the program randomly. On the other hand, the status (ON or OFF) of multi-devices is also chosen randomly in every simulation experiment using ten fields. The flow chart that describes the software design of the system is shown in Figure 4.

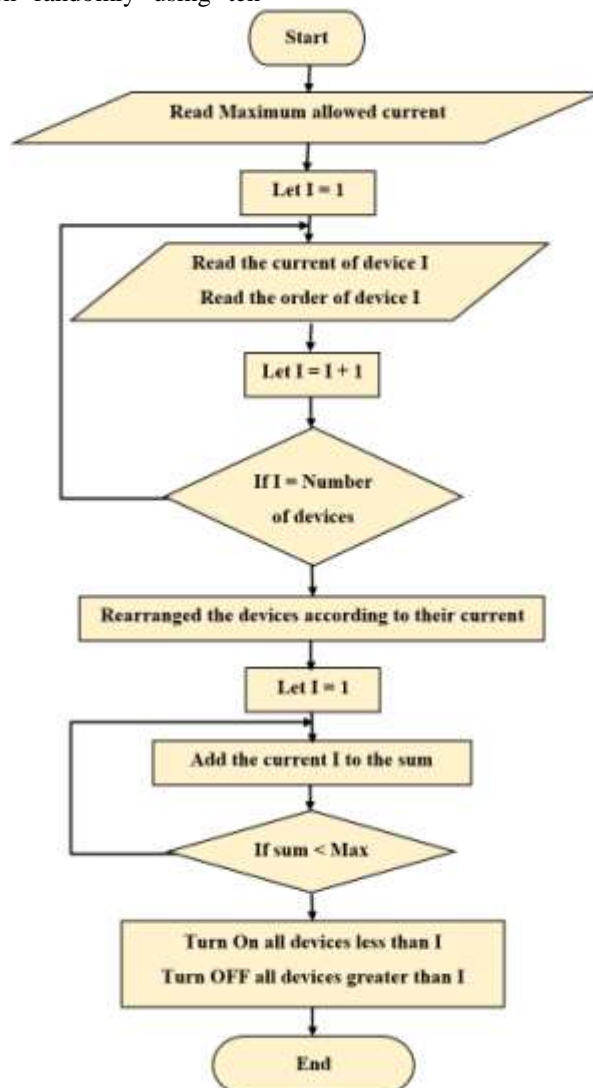

Fig. 4: The flowchart for the proposed system.

At the beginning of the operation process, as shown in the algorithm, a reading of the highest current is taken through the (Combo Box), which is programmed through the software in the

simulation, and after the first implementation of the practical program, the current is divided into classified categories according to priority, and the central control unit begins reading each device, the

extent of its need for current, and the amount of its priority. In the home, and according to the circumstances of the people of the house, for example, unnecessary devices are turned off by turning them off when the people of the house are consumption and thus saving it, and the control unit starts reading all the current devices and storing them in a separated element in a one-dimensional array. Besides that, each device's priority (order of each operation) is stored in another one-dimensional array. Figure 5 show the GUI for the smart home using overvoltage protection techniques. The program starts by selecting the maximum current allowed to each device and storing it in another combo box in the same form. The overvoltage protection scenario is created by rearranging each device's current reading in increasing order, and the same operation is repeated for the order (priority) until reaching a new array by sorting procedure. The overvoltage protection is done by adding the variety's content, and when the amount of current is passed to the maximum allowed current, the operation is stopped. As a result, all the added amount will turn on, and the other is neglected to protect the smart home's overvoltage system. The maximum allowed current is chosen using a Combo Box in the

not present, so that energy is saved and used in other devices or programmed to start operating according(through the Text Boxes) to the time of the people's return to the home, and thus we achieve the absence of high energy proposed form of simulation. When the program is executed, the current for each device is divided into individual Text Boxes, and the control unit starts reading all the current devices and storing them in a separated element in a one-dimensional array. Besides that, each device's priority (order of each operation) is stored in another one-dimensional array. The program starts by selecting the maximum current allowed to each device and storing it in another combo box in the same form. The overvoltage protection scenario is created by rearranging each device's current reading in increasing order, and the same operation is repeated for the order (priority) until reaching a new array by sorting procedure. The overvoltage protection is done by adding the variety's content, and when the amount of current is passed to the maximum allowed current, the operation is stopped. As a result, all the added amount will turn on, and the other is neglected to protect the smart home's overvoltage system.

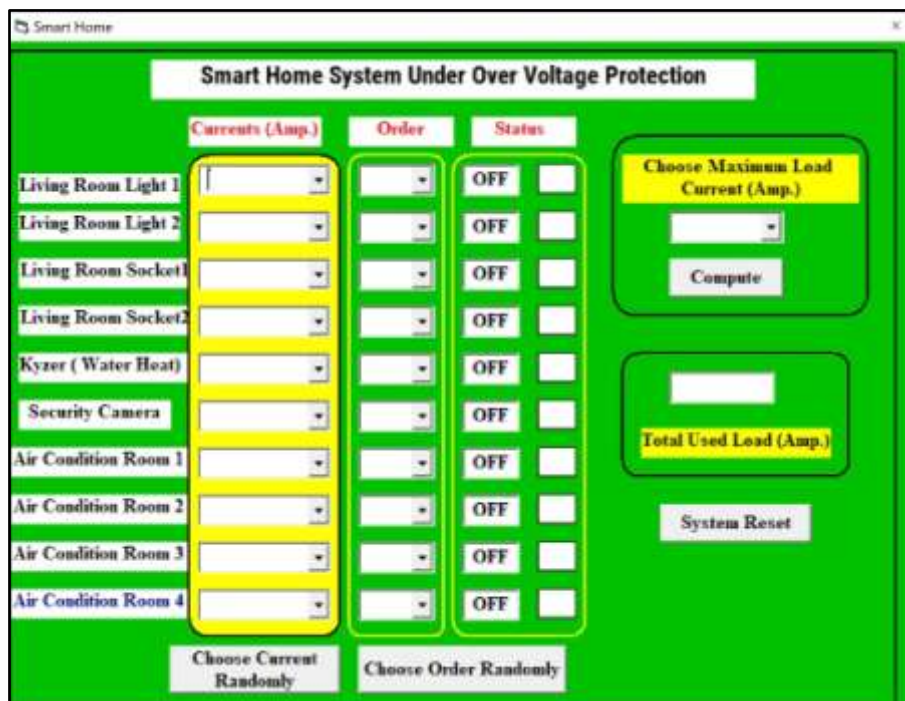

Fig. 5: GUI for the smart home using overvoltage protection techniques.

#### IV. THE SIMULATION RESULTS

In this section, the system is programmed to design and implement a new interface using

virtual reality simulation, where the number of devices composing the house is imposed according to its capacity by programming a special section for

each device in the house and a section regarding the permissible limit of the current that must be taken in this program. It will be assumed that there are ten. There are loads in this house, and therefore what is required is to rationalize the consumption of the energy supplied to it through the smart simulation system. The physical components are designed to be compatible with the virtual design, where the load is allowed to work only in the case of loads that do not cross the range allowed in the corresponding box and thus remain in the on-line state. Any load that exceeds the permissible limit of current is cut off, thus controlling the system. In this simulation, three cases are discussed: the first test is assumed that all the devices are operated under a small number of currents, shown in Figure. 6. While the second test assumes that all the devices are operated under a high current voltage, and the result is shown in Figure. 7. And in the last test, a mixed of current drawn is assumed, where some of them operate under a low current and the other assumes a high current to drive, and the result is shown in Figure. 8. Samples of the results are taken by retrying and taking the results, as we

constantly notice the restart of the practical part and the flow of its work with the simulation part. It shows that the highest value is obtained by consuming the least current. This is due to the fact that increasing the current consumption leads to an increase in the consumed power and thus reducing the rationalization of consumption, and this is not the case. It is included in the proposed system. And the small current load is produced the best results when compared with the other two cases. The experiment is done on an environment with four current sensors (ACS712) to sense the environment and transfer the signal to the central control unit to prevent the overvoltage case in a smart home. On the other hand, the Liquid Crystal Display (LCD) module displays the result from the current drawn by each device. Furthermore, each load is applied with one Lamp. The result of repeat the simulations many times is shown in Fig. 9. Where the range of maximum allowed current is starting from (5 to 50) Amp. The percentage of the maximum allowed current is chosen from (0 to 100) Amp. And three case of loads is used in this simulation: low current load, high current load and maximum current load.

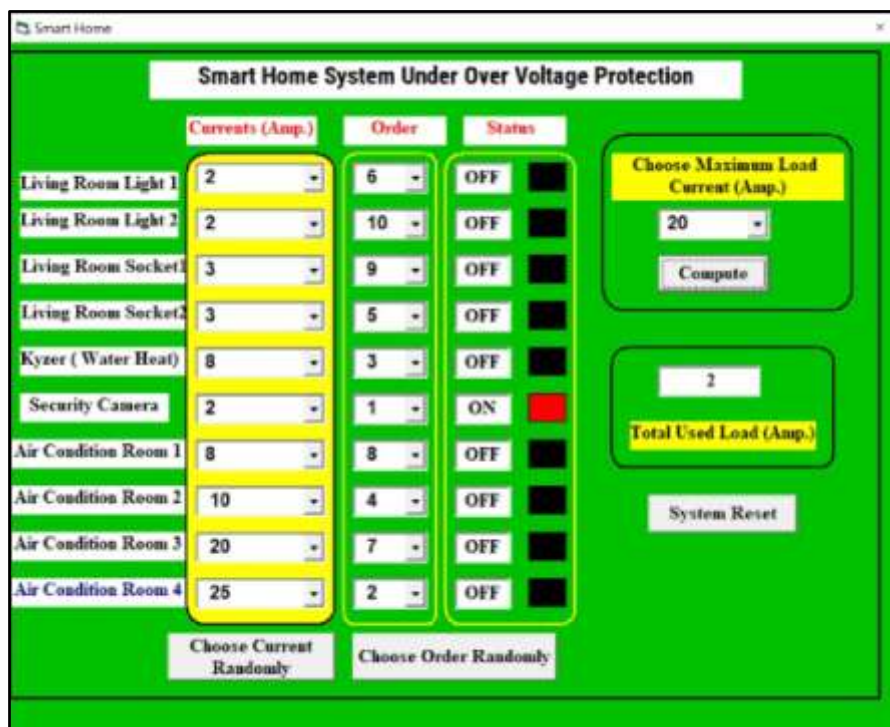

Fig. 6: The Simulation (Graphical User Interface) with low current device.

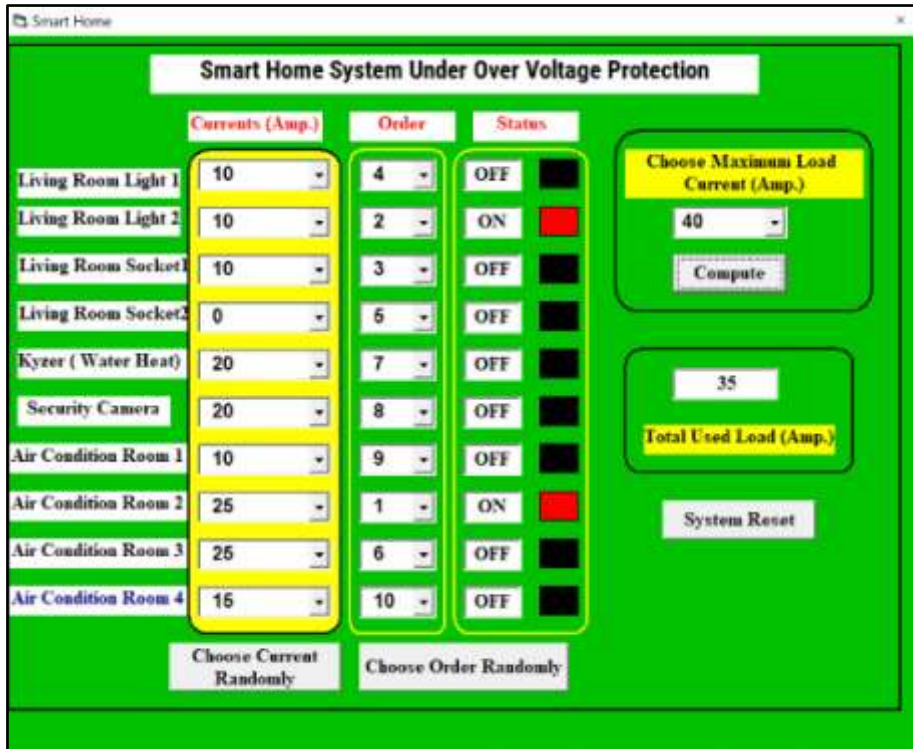

Fig. 7: The Simulation (Graphical User Interface) with high current device.

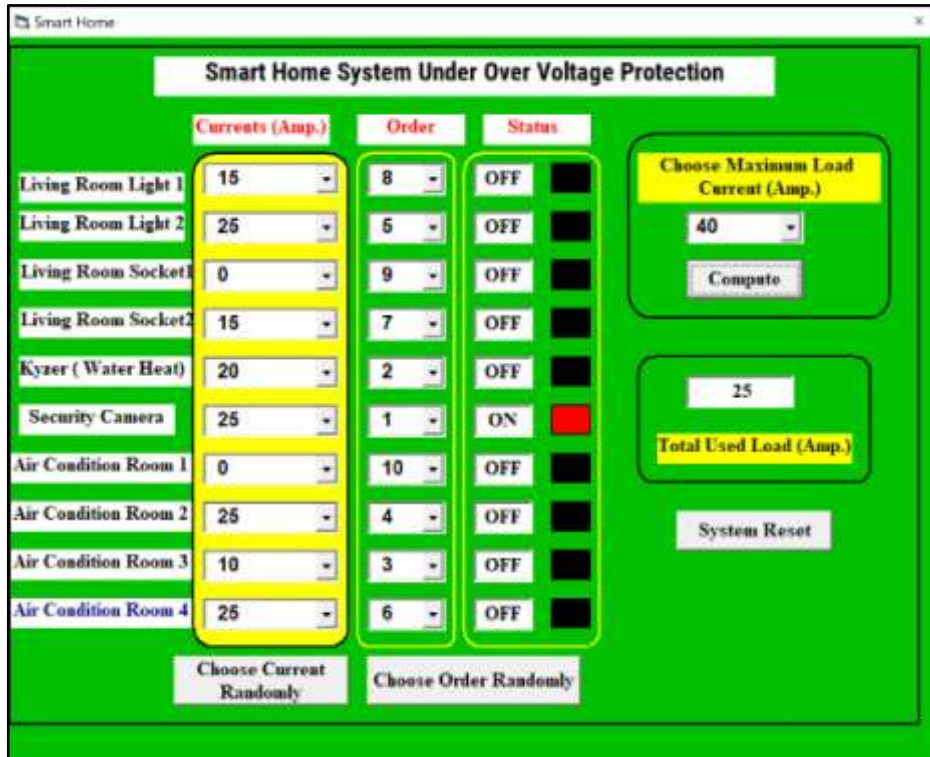

Fig. 8: The Simulation (Graphical User Interface) with mixed current device.



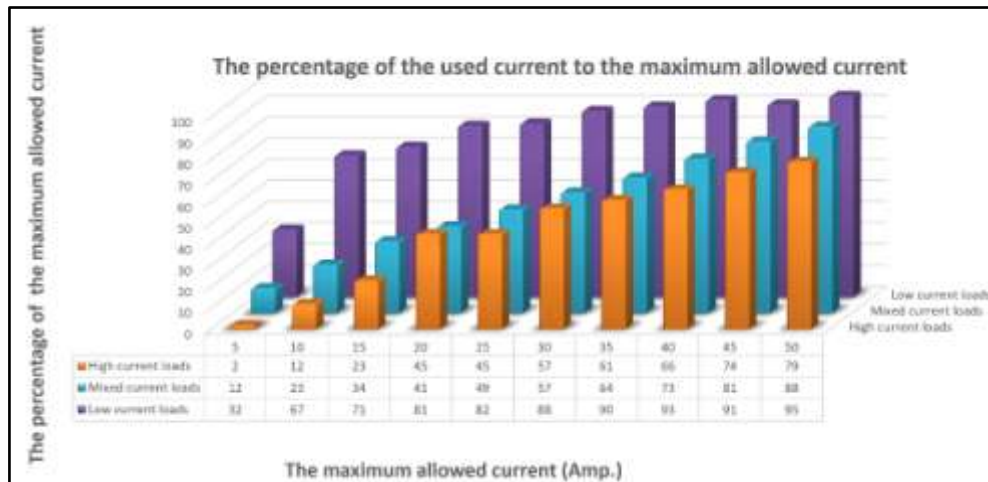

Fig. 9: The Result of Maximum Allowed Current Vs the Consumer Current.

## V. CONCLUSION

In this paper, an overvoltage system protection for a smart home is designed and implemented using hardware and software types of equipment. A prototype for an overvoltage protection system is suggested using the hardware equipment in the hardware design. While in the software, the GUI is used to control the whole system to prevent it from passing the maximum allowed current. The proposed approach is designed on the VB program and implemented using ten loads by controlling the orders' priority. The experiment results show that the current percentage is increased depending on increasing the maximum allowed current. On the other hand, the system obtained a better performance when using the low current loads, while its performance is reduced when using high or mix recent cases. Furthermore, the system built with very cheap components, and it is used to turn ON only the multi-devices with limited current and turn OFF the others. This process will be reduced cost and reduced the required energy. The final results showed that the best value was obtained by consuming the least energy using the lowest possible current by comparing the results in the fields shown within the simulation program.

## REFERENCES

- [1] F. K. Handhal and A. T. Rashid, "A prototype Design for Three Phase Smart Energy Meter", Second Al-Sadiq International Conference on Multidisciplinary in IT and Communication Science and Applications, 2017.
- [2] F. K. Handhal and A. T. Rashid, "Design and building a single-phase smart energy meter using Arduino and RF communication system", Proc. of the 3rd Int. Sci. Conf., (14-15/march/2018).
- [3] A. T. Rashid and M. T. Rashid, "Design and Implementation of Load Balancing System for a Smart Home", Proc. of the 3rd Int. Sci. Conf., (14-15/march/2018).
- [4] F. K. Handhal and A. T. Rashid, "Load Balancing in Distribution System Using Heuristic Search Algorithm", International Conference on Advances in Sustainable Engineering and Applications (ICASEA), Wasit University, Kut, Iraq, pp. 48-53, 2018.
- [5] A. T. Rashid, F. K. Handhal and O. T. Rashid, "Wireless Control system for Three Phase Loads Balancing in Distribution Networks", International Journal of Computer Applications (0975 – 8887) Vol. 182 – No. 7, pp. 38-46, 2018.
- [6] Issa, B.A., Al-Furati, Israa S., "High Precision Binary Coded Decimal (BCD) unit for 128-bit addition", 2nd International Conference on Electrical, Communication and Computer Engineering, ICECCE 2020, 2020, 9179331.
- [7] R. Panna, R. Thesrumluk and C. Chantrapornchai, "Development of Energy Saving Smart Home Prototype", International Journal of Smart Home, Vol. 7, No. 1, pp. 47-66, 2013.
- [8] Al-Furati, Israa S., and Rashid, A. T., "Shortest Distance Orientation Algorithm for Robot Path Planning using Low-Cost IR Sensor System", In 2020 International Conference on Electrical, Communication, and Computer Engineering (ICECCE), pp. 1-6, IEEE, (June, 2020).
- [9] Padmanabh, K., Malikarjuna, A., Sen, S., Katru, S. P., Kumar, A., Vuppala, S. K., & Paul, S. (2009, November). iSense: a

- wireless sensor network based conference room management system. In Proceedings of the First ACM Workshop on Embedded Sensing Systems for Energy-Efficiency in Buildings (pp. 37-42).
- [10] Issa, B. A., & Al-Furati, I. S. (2020, June). High Precision Binary Coded Decimal (BCD) unit for 128-bit addition. In 2020 International Conference on Electrical, Communication, and Computer Engineering (ICECCE) (pp. 1-5). IEEE.
- [11] Lu, J., Sookoor, T., Srinivasan, V., Gao, G., Holben, B., Stankovic, J., ... & Whitehouse, K. (2010, November). The smart thermostat: using occupancy sensors to save energy in homes. In Proceedings of the 8th ACM conference on embedded networked sensor systems (pp. 211-224).
- [12] Al-Furati, I. S., Al-Assfor, F. K., & Abdul Zahra, A. K. (2022, July). Design and Implementation of a Low-Cost Weather Stations Meter. In Proceedings of Seventh International Congress on Information and Communication Technology: ICICT 2022, London, Volume 3 (pp. 167-175). Singapore: Springer Nature Singapore.
- [13] W. Kleiminger, F. Mattern and S. Santini, "Predicting household occupancy for smart heating control: A comparative performance analysis of state-of-the-art approaches", *Energy and Buildings*, Vol. 85, pp.493–505, 2014.
- [14] Ye, Z., O'Neill, Z., Zhang, L., Hu, F., & Chu, Z. (2020). Hardware-Based Emulator for Building Energy Cyber-Physical Control with Occupancy Sensing. In 17th International Conference on Information Technology–New Generations (ITNG 2020) (pp. 493-499). Springer, Cham.
- [15] Sarah Sabeeh, Israa S. Al-Furati. Iraqi Journal for Electrical and Electronic Engineering, "Issues and Research Fields of Medical Robotics: A Review". Vol.19, Issue 2, December 2023. DOI: 10.37917/ijeee.19.2.16.
- [16] Zhang, J., Zhang, B., Yu, Y., & Wang, C. M. (2019). First-principles insights of electronic and optical properties of F-doped hexagonal boron nitride nanosheets for photo-catalytic water splitting. *EPL (Europhysics Letters)*, 127(6), 67003.
- [17] Al-Furati Israa S\*. PriMera Scientific Engineering, "Design and Implementation of a Control Water Quality System using IOT", Volume 4 Issue 3 March 2024 ISSN: 2834-2550A. PriMera Scientific Engineering Volume 4 Issue 3 March 2024 DOI: 10.56831/PSEN-04-111 ISSN: 2834-2550. Al-Furati Israa S. "Design and Implementation of a Control Water Quality System using IOT". *PriMera Scientific Engineering* 4.3 (2024): 13-24.
- [18] Mahlein, J., & Braun, M. (2000, August). A matrix converter without diode clamped over-voltage protection. In Proceedings IPEMC 2000. Third International Power Electronics and Motion Control Conference (IEEE Cat. No. 00EX435) (Vol. 2, pp. 817-822). IEEE.
- [19] AL-Furati, I., Rashid, A. T., and Al-Ibadi, A., "IR sensors array for robots' localization using K means clustering algorithm", *International Journal of Simulation Systems, Science & Technology*, Vol.12, No.1, (March, 2019).
- [20] Adoghe, A. U., & Odigwe, I. A. (2009). Automatic Transfer and Controller System for Standby Power Generator. In *Advanced Materials Research* (Vol. 62, pp. 187-193). Trans Tech Publications Ltd.
- [21] Scotta, I. C., Ribeiro, G. M., Maidana, W., & Leite, V. (2019, October). Over-voltage protection for Pico-Hydro generation using PV microinverters. In *Ibero-American Congress of Smart Cities* (pp. 25-37). Springer, Cham.
- [22] AL-Furati, I. S., and Rashid, A. T., "Performance Comparison of Three Types of Sensor Matrices for Indoor Multi-Robot Localization", *International Journal of Computer Applications*, Vol.181, No.26, pp22-29, 2018.