

The effect on S type Probe with inter tube spacing

‘Vikas rajbhar , Pankaj kumar

Student Dr. A. P.J. Abdul kalam technical university

Submitted: 01-07-2021

Revised: 13-07-2021

Accepted: 16-07-2021

ABSTRACT: This research paper is about velocity measurement in pipe. What is problem facing at velocity measurement in pipe full analysis in this research paper. To analyse the variation of turbulent effect of S-type pitot tube with the inter tube spacing over the Reynolds number range 1000 to 13000. It is also observed the coefficient variation of the pitot tube over the Reynolds number range. S type pitot tube coefficient an experimental work has been carried out in a wind tunnel, the result of the present work showed that there a slight dip over a Reynolds number range 1000 to 4000 (velocity range 2 to 15m/s). For higher Reynolds number the coefficient of S-type pitot tube display almost constant value. S-type pitot tube with inter tube spacing is to use to find velocity of dusty environment and slurry flow it is also use in chimney.

Keywords: 2- hole offset probes, S-type pitot tube coefficient ; wind tunnel test;

I. INTRODUCTION

S-type probe is used to determine the stack gas velocity and volumetric flow rate for stack or dusty environment. It is widely used for high concentration slurry because obstruction does not occur during flow in the tube.

During the measurement with an S-type probe it was noticed that this probe coefficient showed a dip in a certain range of speeds. This

project was undertaken to determine if this dip is real and if so how it varies with Reynolds number.

L-type probe is bent by 90° between leg length and nominal length therefore obstruction occurs during the slurry flow. When particles pass through bend, they are trapped and this type of obstruction stops the fluid flow in L-type probe. Therefore S-type probe is used instead of L-type probe.

Manufacturing process of S-type probe is easier than L-type probe, and manufacturing cost is also less.

Normally, S-type probes are calibrated in terms of a pitot coefficient which is defined as

$$C_{p\ s\text{-type}} = \frac{V_{\text{air}}}{\sqrt{\frac{2(p_f - p_a)}{\rho_{\text{air}}}}}$$

Where $C_{p\ s\text{-type}}$ = coefficient of S-type probe

V_{air} = velocity of air in wind tunnel

p_f = pressure measure in the forward facing port of S-type probe (pa)

p_a = pressure measure in the rearward facing port of S-type probe (pa)

A probe coefficient is 0.85, generally accepted value for S-type probes.

S-type probe is made of metal tubing (e.g. stainless steel) as shown in Figure 1. External tubing diameter (D) is taken between 1.23mm and 9.54mm. There is equal distance from the base of each leg of the pitot tube to its face opening plane.

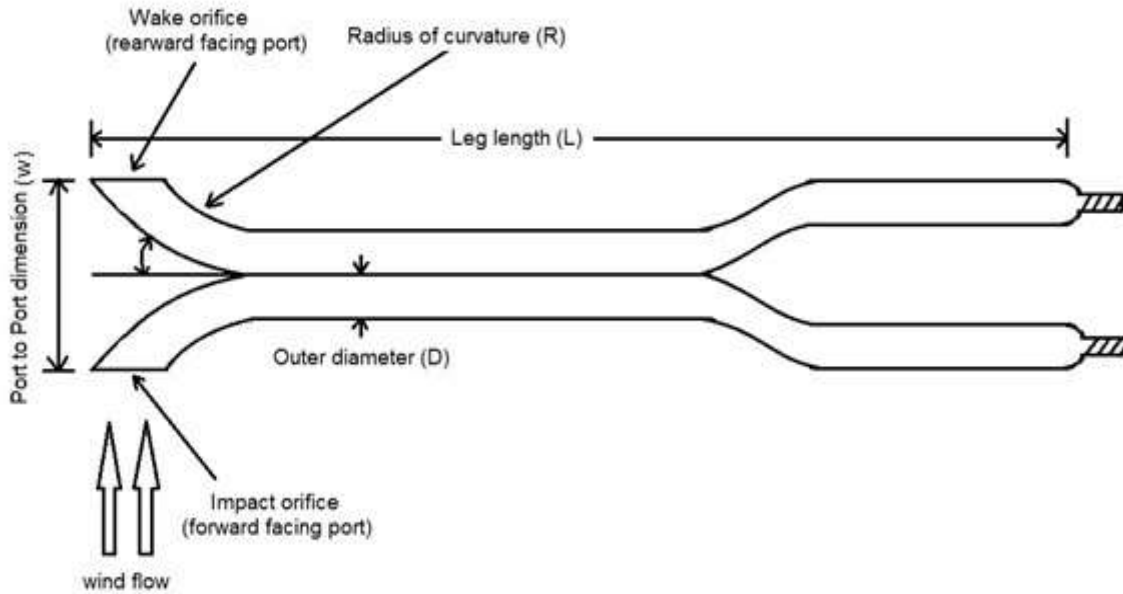

Fig 1: S-type probe and nomenclature

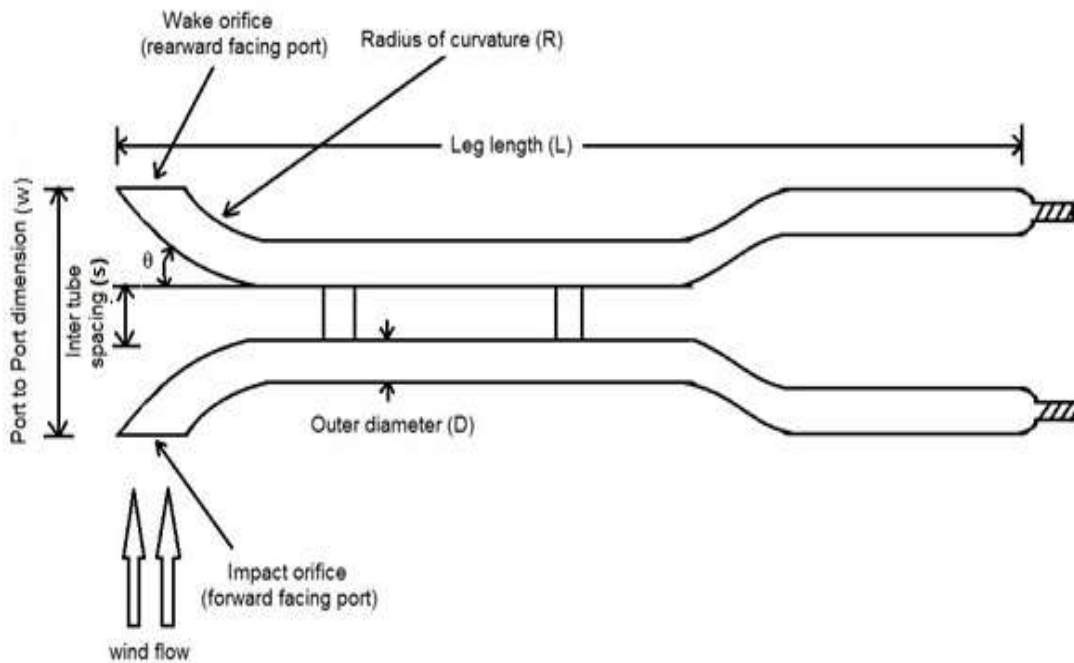

Fig 2: S-type probe with inter tube spacing and nomenclature

Pitot-Static Tube

The pressure measured by the pitot-static tube is essentially the difference between the total and static pressure. It is the system of pressure sensitive instruments that is most often used in

aviation to determine an aircraft's airspeed. A pitot-static system generally consists of a L-type probe, a static port and pitot-static instruments. Total pressure of pitot-static tube is also called stagnation pressure.

$$\begin{aligned} \text{Total pressure} &= \text{dynamic pressure} + \text{static pressure} \\ p_t &= p_d + p_s \\ \text{then } p_t &= \frac{1}{2} \rho_{\text{air}} v_{\text{air}}^2 + p_s \end{aligned}$$

In fluid dynamics, stagnation pressure (also known as pitot pressure) is the static pressure at a stagnation point in a fluid flow. At a stagnation point the fluid velocity is zero and all kinetic energy has been converted into pressure energy (isentropically).

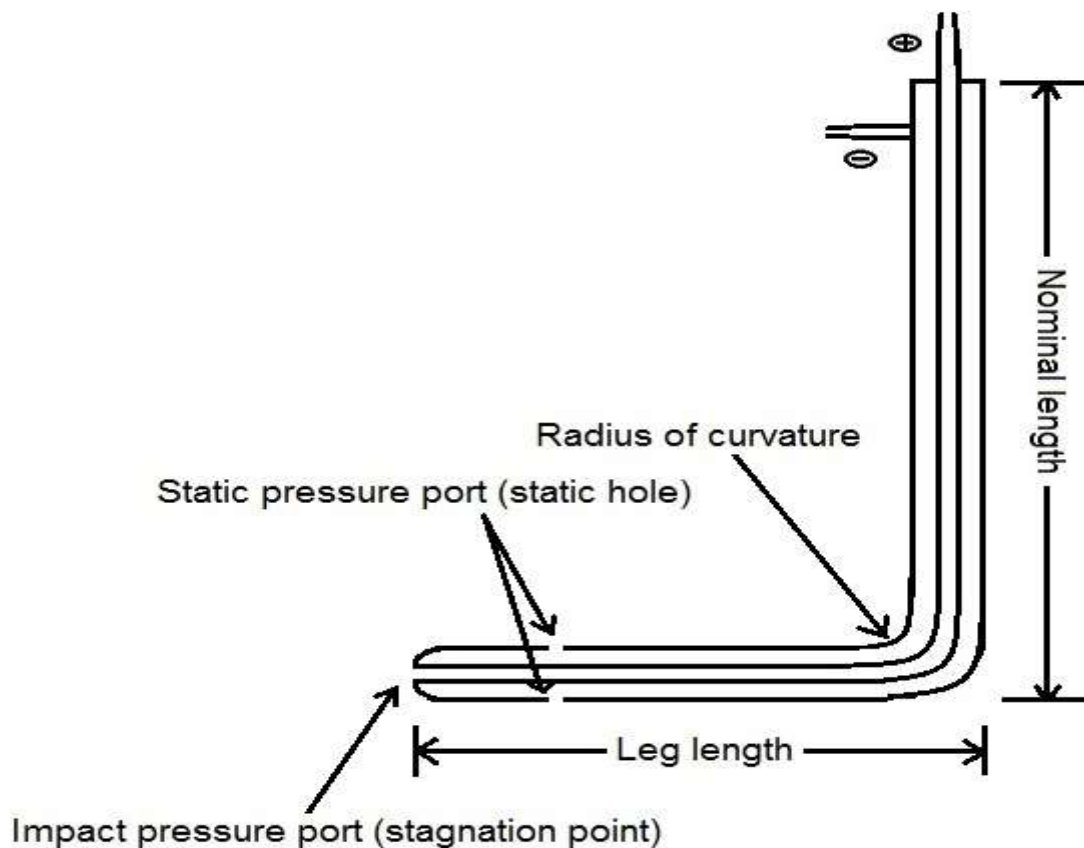

Fig 3: A schematic drawing of a pitot-static tube (also called Prandtl tube)

Experimental setup

1. Both the S-type probe and L-type probe are fixed properly in the center of test section (0.58m × 0.34m × 0.34m) of wind tunnel at the same downstream location.
2. Case was taken to ensure that the probes are properly aligned with the flow so that yaw and pitch effects are not introduced.
3. The two probes were kept sufficiently apart so that no aerodynamic interference was present.
4. Now both pitot tubes are connected with manometer through plastic pipes properly.
5. Leakage of air around the test section in wind tunnel is also checked.

Procedure of the Experiment

1. S-type and L-type probes are mounted in the center of wind tunnel (0.58m × 0.34m × 0.34m) as shown in figure 5.
2. Fan-1 is switched on and the frequency is increased by a step of 5 Hz, starting from zero to 50 Hz.
3. For each frequency the reading is taken in the manometers (for the both S-type probe and L-type probe).
4. Once the fan-1 reaches the frequency of 50 Hz, fan-2 is switched on.
5. Now frequency of fan-2 is also increased from 0 to 50 Hz with a step of 5 Hz. Again for each step the manometer reading is noted down.
6. When fan-2 reaches 50 Hz the frequency is noted as 50+50 Hz.

7. Now frequency of fan-2 is lowered from 50 to 0 Hz with step of 5 Hz. And the reading of manometer is noted.
8. The frequency of fan-1 is reduced with step of 5 Hz from 50 to 0 Hz and noted the manometer reading.
9. Repeated this experiment for different dimensions of S-type probes.

Fabrication of S-type probes

- Design of S-type probe depends upon the Port to Port dimension, radius of curvature, angle of bend and arc length but is independent of tube length, diameter and fluid flowing in the tunnel.
- Tube length and diameter of S-type probe is only related to the **response time** and it only depends upon the application. It does not effect on the probe coefficient.
- **Response time** is inversely proportional to fourth power of diameter and directly proportional to the tube length of pitot tube.

$$t = \frac{128\mu L}{\pi d^4} \left[\frac{A}{2\rho_{Hg}g} + \frac{V}{p_2} \right]$$

(Nakra and Chaudhary 2003)

- where t = response time (second)
d = internal diameter of S-type pitot tube (cm)
 μ = dynamic viscosity of the fluid ($\mu\text{Pa-s}$)
A = area of cross section of manometer (cm^2)
V = volume of space (cm^3)
 p_1 and p_2 = absolute pressure at the beginning and end of the tube respectively (pa)
g = acceleration of gravity (m/s^2)
- If tube length increases, the response time also increases which means more time to get

the manometer reading. Therefore it is necessary to reduce the tube length and increase the inner diameter to lower the response time.

- Dimensions of S-type probe have taken in term of tube diameter (D).

Five different sets of S-type probes are manufactured and tested.

- (A) Standard S-type probe with variation only in diameter (D)
- (B) Variation of bend angle (θ) for a fixed diameter of S-type probes.
- (C) Variation of inter tube spacing (s) for a fixed diameter of S-type probes.
- (D) Repetition of case B with solid head.
- (E) Variation of port to port distance (w) for a fixed diameter of S-type probes

Variation of inter tube spacing (s) for a fixed diameter of S-type probes.

The effect of inter-tube spacing on probe coefficient and Reynolds number in the velocities ranging from 3 m/s to 30 m/s needs to be investigated here.

Five 6.0 mm diameter S-type probes at 86° with different inter tube spacing are fabricated and taking tube length as small as possible.

1. 6 mm Diameter(D) at 86° angle with 0.0 mm inter tube spacing

- Tube length (L) = 15.5 inch
Angle of bend (θ) = 86°
Radius of curvature (R) = $2.083D = 12.5$ mm
Arc length of tube = $0.833D = 5.0$ mm
Port to Port distance (P-P) = $2.825D = 16.95$ mm

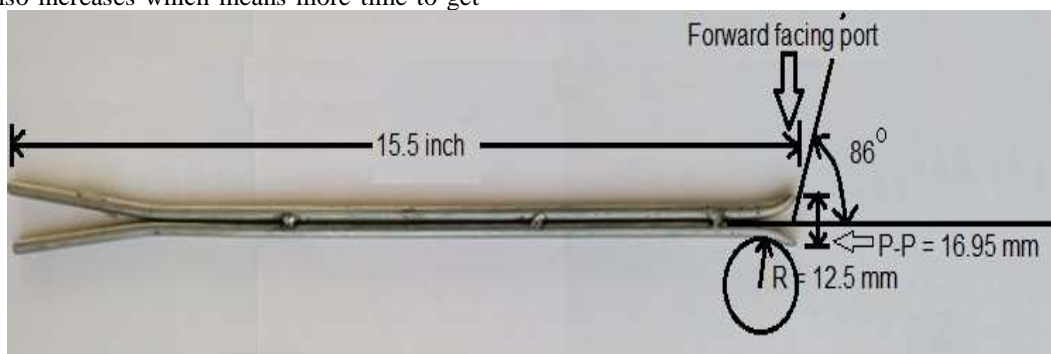

Fig 15: Diagram of 6.0 mm S-type probe at 86° with 0.0 mm inter tube spacing

2. 6 mm Diameter(D) at 86° angle with 2.5 mm inter tube spacing

Tube length (L) = 15.5 inch

- Angle of bend (θ) = 86°
Radius of curvature (R) = $2.083D = 12.5$ mm
Arc length of tube = $0.833D = 5.0$ mm
Port to Port distance (P-P) = 19.45 mm

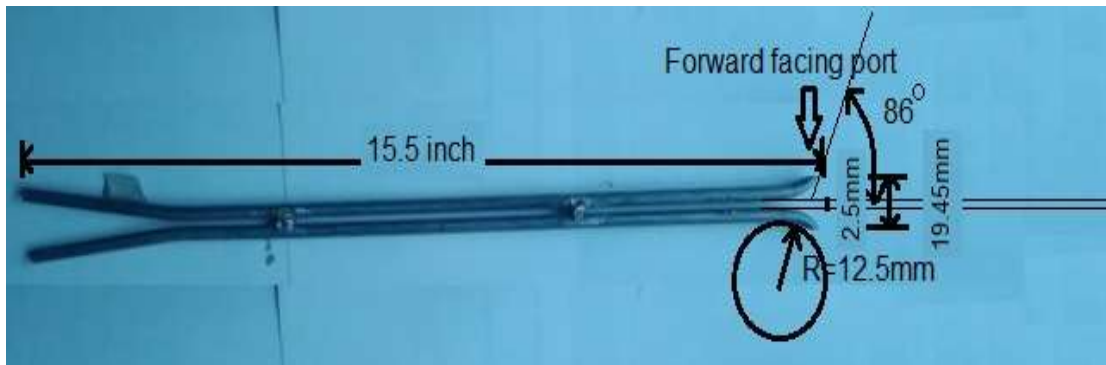

Fig 16: Diagram of 6.0 mm S-type probe at 86° with 2.5 mm inter tube spacing

3. 6 mm Diameter(D) at 86° angle with 5.0 mm inter tube spacing

Tube length (L) = 15.5 inch

Angle of bend (θ) = 86°

Radius of curvature (R) = $2.083D = 12.5$ mm

Arc length of tube = $0.833D = 5.0$ mm

Port to Port distance (P-P) = 21.95 mm

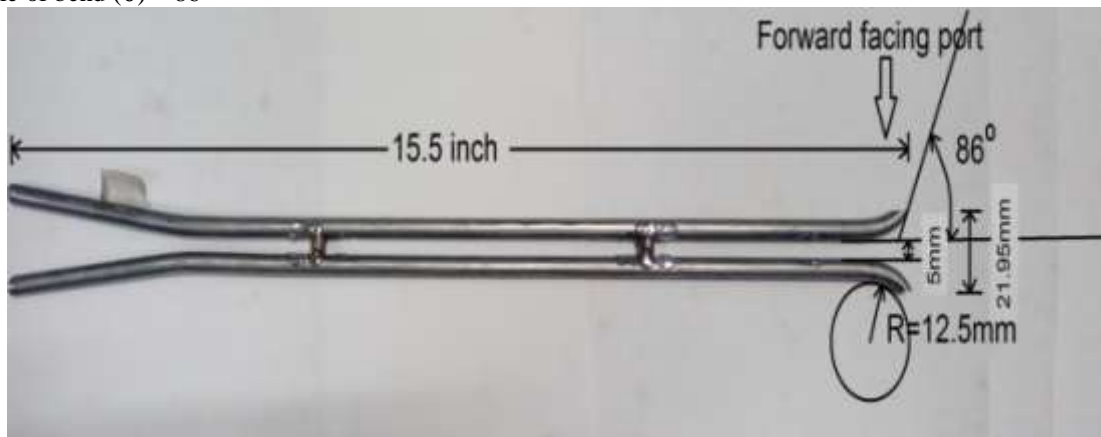

Fig 17: Diagram of 6.0 mm S-type probe at 86° with 5.0 mm inter tube spacing

4. 6 mm Diameter(D) at 86° angle with 7.5 mm inter tube spacing

Tube length (L) = 15.5 inch

Angle of bend (θ) = 86°

Radius of curvature (R) = $2.083D = 12.5$ mm

Arc length of tube = $0.833D = 5.0$ mm

Port to Port distance (P-P) = 24.45 mm

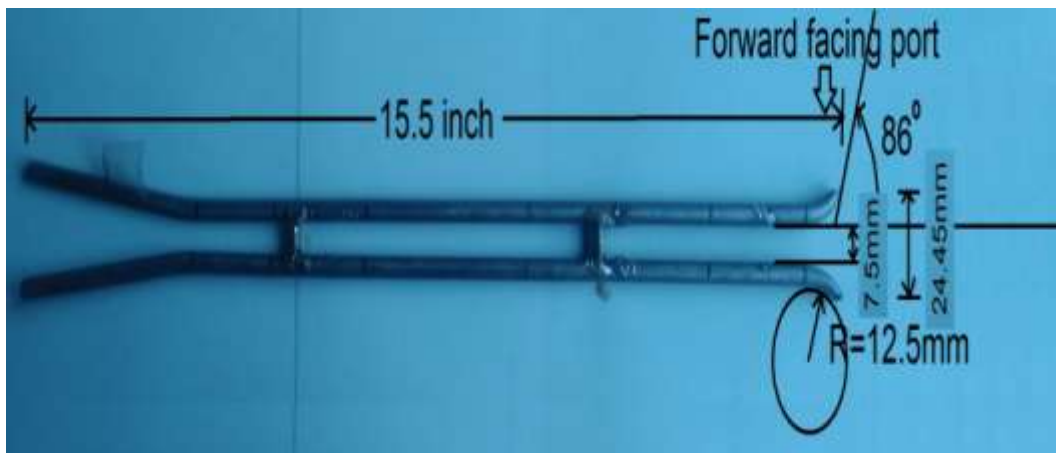

Fig 18: Diagram of 6.0 mm S-type probe at 86° with 7.5 mm inter tube spacing

5. 6 mm Diameter(D) at 86° angle with 10.0 mm inter tube spacings
 Tube length (L) = 15.5 inch
 Angle of bend (θ) = 86°

Radius of curvature (R) = 2.083D = 12.5 mm
 Arc length of tube = 0.833D = 5.0 mm
 Port to Port distance (P-P) = 26.95 mm

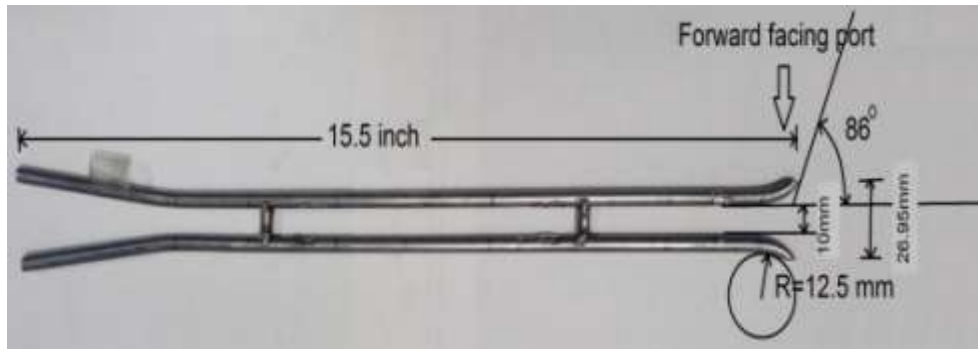

Fig 19: Diagram of 6.0 mm S-type probe at 86° with 10.0 mm inter tube spacing

Table 3: Dimension of 6.0 mm diameter of S-type probes with different inter tube spacing at 86°

S.No.	Diameter (D) in mm	Probe length (L) in m	Angle of bend (θ)	Inter tube spacing (s) in mm	Port to Port dimension (w) in mm	Radius of curvature (R) in mm	L/D
1	6.0	0.39	86°	0.0	16.95	12.50	65
2	6.0	0.39	86°	2.5	19.45	12.50	65
3	6.0	0.39	86°	5.0	21.95	12.50	65
4	6.0	0.39	86°	7.5	24.45	12.50	65
5	6.0	0.39	86°	10.0	26.95	12.50	65

II. RESULT AND DISCUSSIONS

Result of S-type probes of 6.0 mm diameter at 86° with different inter tube spacing For 6.0 mm diameter of S-shaped probe at 86° with 0.0 mm inter tube spacing

It can be seen that fluctuation in the pressure difference between Port-A and Port-B because of unstable turbulence patterns shedding from the forward facing port and passing over the rearward facing port. Effect of pressure of the forward facing port to that of the rearward facing port is large because port to port dimension is less than that of other four S-type probe with port to port dimension. Therefore, fluctuation in pressure difference is more than that of large port to port dimension.

From figure 41, it is observed that there is no dip in the coefficient value. Experiment was conducted for S-type probe with 0.0 mm inter tube spacing in the range of $937 < Re < 13008$. Coefficient value shows more scatter for Reynolds

number 937 to 5349 and corresponding coefficient value range from 0.858 to 0.826. Thereafter coefficient value increases upto 0.839 where Reynolds number is 6897 and then shows nearly constant value. Therefore coefficient value (C_p) is normalized at 0.828 and 81.81% of coefficient values in set of data are smaller than or equal to normalized value (0.828). Experimental data for 6.0 mm diameter at 86° angle with 0.0 mm inter tube spacing of S-type probe is given in table 32.

We have drawn the error bar for some coefficient point in the graph. The error in coefficient value decreases when Reynolds number increase, for Reynolds number range of 1000 to 4000 the error is in between $\pm 5\%$ and $\pm 1\%$. Also for Reynolds number greater than 4000, error is less than $\pm 1\%$. After investigation we found that this type of error trend is shown in all experiments for 6.0 mm diameter of S-type probes at 86° angle with different port to port dimension.

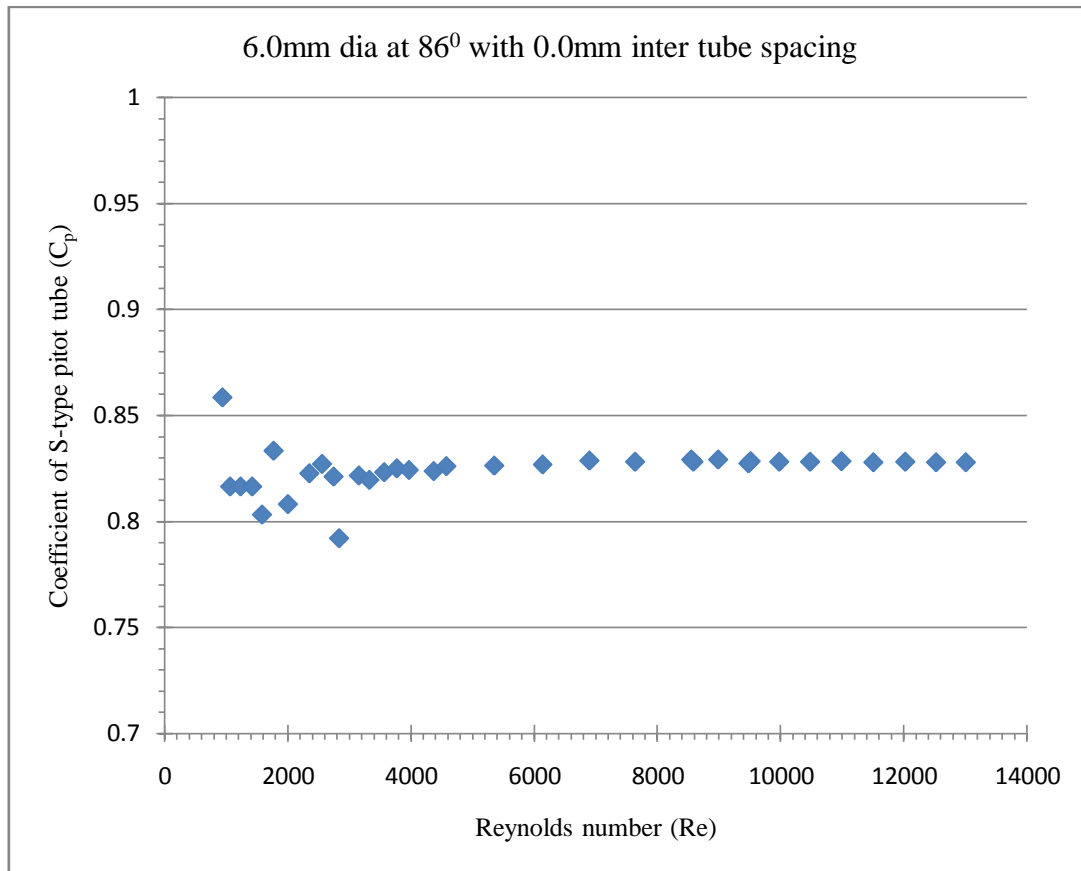

Reynolds number effects on the 6.0 mm diameter S-type probe at 86° with 0.0 mm inter tube spacing

For 6.0 mm diameter of S-shaped probe at 86° angle with 2.5 mm inter tube spacing

From figure 42, here port to port dimension is large than that of 6.0 mm diameter of S-type probe at 86° angle with 0.0 mm inter tube spacing. Therefore, effect of pressure of the forward facing port to that of the rearward facing port is less. Here large eddies are generated in between these two ports due to flow separation is less than that of 0.0 mm port to port dimension. Therefore, fluctuation in pressure difference is less than that of 0.0 mm port to port dimension.

It is observed that there is no dip in the coefficient value. Experiment was conducted for S-

type probe with 2.5 mm inter tube spacing in the range of 1050 < Re < 12812. Coefficient value shows more fluctuation in wide range of Reynolds number from 1050 to 4499 and corresponding coefficient value range from 0.832 to 0.850. Thereafter coefficient value decreases upto 0.843 where Reynolds number is 10320 and then shows nearly constant value. Therefore coefficient value (Cp) is normalized at 0.843 and 42.42% of coefficient values in set of data are smaller than or equal to normalized value (0.843). Experimental data for 6.0 mm diameter at 86° with 2.5 mm inter tube spacing of S-type probe is given in table 33.

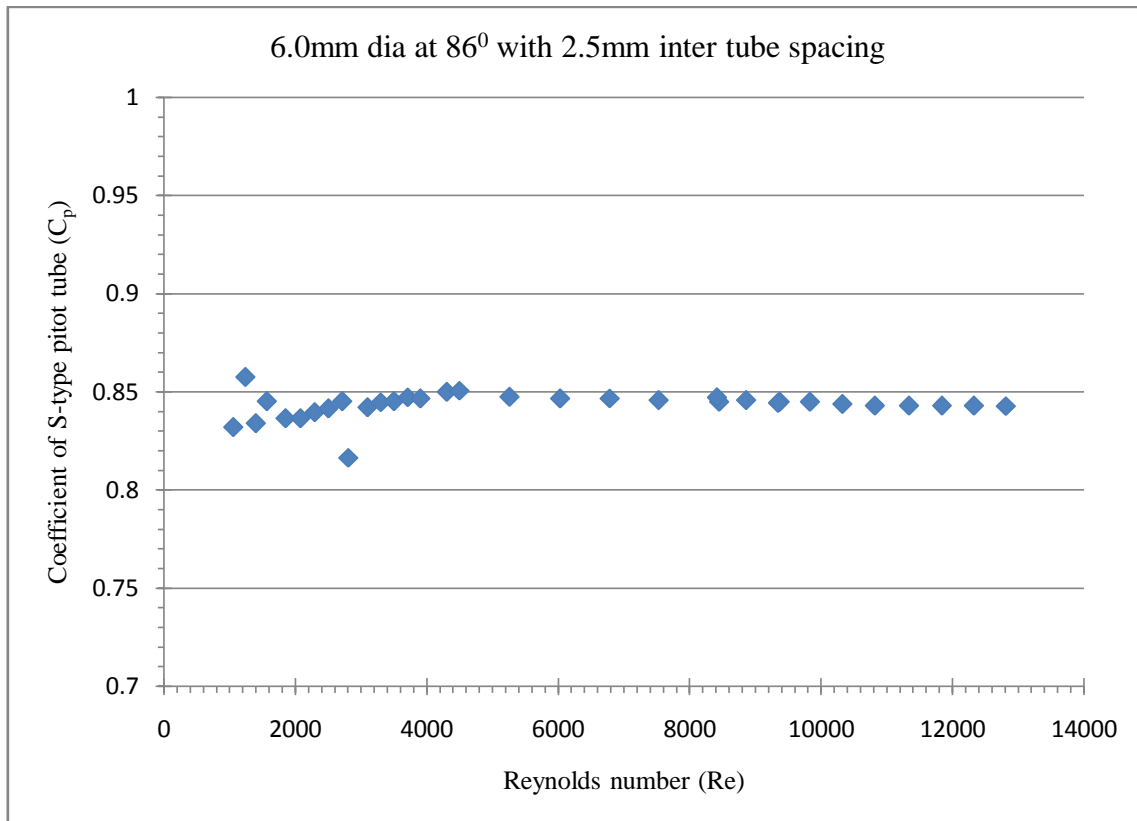

Reynolds number effects on the 6.0 mm diameter S-type probe at 86° with 2.5 mm inter tube spacing

REFERENCES

- [1]. Kang Woong, Trang Nguyen Doan, Lee Hee Saeng, Choi Man Hae, Shim Jae Sig and Choi Yong Moon (2015). "Experimental and numerical investigations of the factors affecting the S-type Pitot tube coefficients." *Flow Measurement and Instrumentation* 44 (2015) 11–18.
- [2]. Koech Richard (2015). "Water density formulations and their effect on gravimetric water meter calibration and measurement uncertainties." *Flow Measurement and Instrumentation* 45 (2015) 188-197.
- [3]. Spelay Ryan B., Adane Kofi Freeman, Sanders R. Sean, Sumner Robert J. and Gillies Randall G. (2014). "The effect of low Reynolds number flows on pitot tube measurements." *Flow Measurement and Instrumentation* 45 (2014) 247-254.
- [4]. Crowley Christopher, Shinder Iosif I. and Moldover Michael R. (2013). "The effect of turbulence on a multi-hole Pitot calibration." *Flow Measurement and Instrumentation* 33 (2013) 106-109.
- [5]. Vinod V., Chandran T., Padmakumar G. and Rajan K. K. (2012). "Calibration of an averaging pitot tube by numerical simulations." *Flow Measurement and Instrumentation* 24 (2012) 26 – 28.
- [6]. Trang Nguyen Doan, Kang Woong, Shim Jae Sig, Jang Hee Soo, Park Seung Nam and Choi Yong Moon (2012). "Experimental study of the factors effect on the s type pitot tube coefficient." *IMEKO-WC-2012-TC9-05*.
- [7]. Kabacinski M. and Pospolita J. (2007). "Numerical and Experimental research on new cross section of averaging pitot tube." *Flow Measurement and Instrumentation* 19 (2008) 17-19.
- [8]. Nakra B. C. and Chaudhary K. K. (2003). "Instrumentation Measurement and Analysis."
- [9]. Indian Standard (2001). "Measurement of fluid flow in closed conduits." *Velocity Area Method Using Pitot Static Tubes IS (2001) 14973*.